

Defibtech DDU-120 Fully-Automatic External Defibrillator



User Manual

For comprehensive training
on set-up, use and maintenance;
source for complete technical
specifications



ELECTRONIC
DISTRIBUTION

DAC-E570-EN-DA

1



2

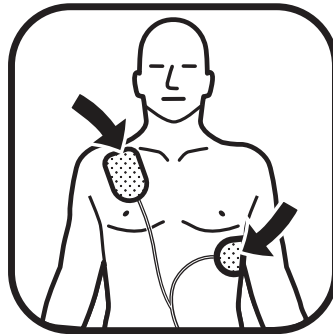
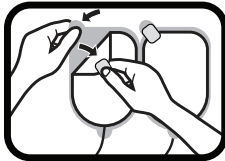
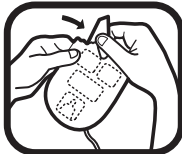

3



Notices

Defibtech shall not be liable for errors contained herein or for incidental or consequential damages in connection with the furnishing, performance, or use of this material.

Information in this document is subject to change without notice. Names and data used in any examples are fictitious unless otherwise noted.

Limited Warranty

The "Limited Warranty" shipped with Defibtech AED products serves as the sole and exclusive warranty provided by Defibtech, L.L.C. with respect to the products contained herein.

Copyright

Copyright © 2016 Defibtech, L.L.C.

All rights reserved. Copyright questions should be directed to Defibtech. For contact information, refer to the "Contacts" section of this manual.

Tracking

U.S.A. federal regulations require Defibtech to maintain records for each AED it distributes (reference 21 CFR 821, Medical Device Tracking). These requirements also apply anytime there is a change in the AED's location, including if you move, sell, donate, give away, export or even throw it away. We depend on AED owners/users to contact us when these things happen to ensure the tracking information remains accurate in the event we need to share important product notices. If your location is outside the U.S.A., we ask you share your information for exactly the same reasons. To keep your information up to date, please visit www.defibtech.com/register.



CAUTION: Federal law (USA) restricts this device to sale by or on the order of a physician.

Contents

1	Introduction to the DDU-120 AED	1
1.1	Overview	1
1.2	The Defibtech DDU-120 AED	2
1.3	Indications	4
1.4	Contraindications	4
1.5	Operator Training Requirements	4
2	Dangers, Warnings, and Cautions	5
2.1	Dangers	5
2.2	Warnings	5
2.3	Cautions	9
3	Setting Up the DDU-120 AED	11
3.1	Overview	11
3.2	Installing the Defibtech Data Card (“DDC”)	12
3.3	Installing the Active Status Indicator 9V Battery	12
3.4	Installing and Removing the Battery Pack	13
3.5	Connecting the Pads	13
3.6	Performing Manually-Initiated Self-Tests	14
3.7	Storing the AED	15
4	Using the DDU-120 AED	16
4.1	Overview	16
4.2	Checking the AED Status	17
4.3	Turning on the AED	17
4.4	Preparation	18
4.4.1	Call for Help	18
4.4.2	Preparing the Patient	18
4.4.3	Opening the Pad Package	18
4.4.4	Connecting the Defibrillation Pads to the AED	18
4.4.5	Applying Pads to the Patient	19
4.4.6	Follow AED Prompts	20
4.5	Heart Rhythm Analysis	20
4.6	Delivering the Shock	20
4.7	No Shock Required	21
4.8	Post-Shock CPR	21
4.9	Post-Use Procedures	21

4.10 AED Voice Prompts	22
4.10.1 <i>General Prompts</i>	22
4.10.2 <i>Pad Connection/Pad Application-Related Prompts</i>	22
4.10.3 <i>Motion/Interference Prompts</i>	24
4.10.4 <i>Heart Rhythm Analysis Prompts</i>	24
4.10.5 <i>Shock-Related Prompts</i>	25
4.10.6 <i>No Shock Required Prompts</i>	26
4.10.7 <i>CPR Prompts</i>	26
4.11 LED Indicators	27
4.12 Operational Environment	27
5 Maintaining and Troubleshooting the DDU-120 AED	28
5.1 Self-Tests	28
5.2 Routine Maintenance	29
5.2.1 <i>Checking the Active Status Indicator (“ASI”)</i>	29
5.2.2 <i>Maintenance-Related Prompts</i>	30
5.2.3 <i>Checking the Condition of the AED and Accessories</i>	31
5.2.4 <i>Replacing the Pads</i>	31
5.2.5 <i>Checking Pad and Battery Pack Expiration Dates</i>	32
5.2.6 <i>Checking the Defibtech Data Card</i>	32
5.2.7 <i>Checking the AED Software Version Number</i>	33
5.2.8 <i>Running an Application from a Defibtech Data Card</i>	33
5.3 Replacing the Active Status Indicator 9V Battery	34
5.4 Cleaning	35
5.5 Storage	35
5.6 Operator’s Checklist	36
5.7 Troubleshooting	37
5.8 Repair	39
6 DDU-120 AED Accessories	40
6.1 Defibrillation Pads	40
6.2 Battery Packs	40
6.2.1 <i>Active Status Indicator 9V Lithium Battery</i>	41
6.3 Defibtech Data Cards (“DDC”)	41
6.4 Recycling Information	42
6.4.1 <i>Recycling Assistance</i>	42
6.4.2 <i>Preparation</i>	42
6.4.3 <i>Packaging</i>	42
6.4.4 <i>Notice to European Union Customers</i>	42

7	Event Viewing	43
7.1	DefibView	43
7.2	Defibtech Data Cards (DDC Cards).....	43
7.3	Downloading the Internal Data Log.....	44
7.3.1	Downloading the Internal Data Log Using a DDC Card	44
8	Technical Specifications.....	45
8.1	Defibtech DDU-120 AED.....	45
8.1.1	General.....	45
8.1.2	Environmental.....	45
8.1.3	Defibrillator.....	46
8.1.4	Waveform Specifications.....	47
8.1.5	Patient Analysis System.....	48
8.1.5.1	Shockable Rhythm Criteria.....	48
8.1.5.2	Patient Analysis System Performance.....	49
8.1.6	Clinical Summary.....	49
8.1.6.1	Background.....	49
8.1.6.2	Methods.....	50
8.1.6.3	Results.....	50
8.1.6.4	Conclusion	50
8.1.7	Electromagnetic Conformity.....	51
8.2	Battery Packs	55
8.2.1	High-Capacity Lithium Battery Pack.....	55
8.2.2	Standard Lithium Battery Pack.....	55
8.3	Defibrillation Pads.....	56
8.4	Defibtech Data Cards (DDCs).....	56
8.5	DefibView	57
9	Glossary of Symbols.....	58
10	Contacts.....	61
11	Warranty Information	62

1 Introduction to the DDU-120 AED



IMPORTANT NOTE: This User Manual only applies to DDU-120 AEDs running software version 3.2 or higher that include the marking shown at left on the rear panel AED pad holder label (see Section 5.2.7 for details).

Please refer to www.defibtech.com/support for information about DDU-120 AEDs running earlier software versions.

This User Manual provides information to guide trained operators in the use and maintenance of the Defibtech DDU-120 Automated External Defibrillator (“AED”) and its accessories. It includes comprehensive training on set-up, use, and maintenance and is the source for complete technical specifications. This chapter includes an overview of the AED, a discussion of when it should and should not be used, and information on required operator training.

1.1 Overview

The DDU-120 AED is designed to be easy to use, portable, and battery powered. Voice prompts and visual indicators provide a simple interface for the operator. The AED is capable of recording event information including ECG, audio data (optional), and SHOCK/NO-SHOCK recommendations.

The DDU-120 is a fully-automatic external defibrillator. It has only one user control: the ON/OFF button. It WILL shock a patient automatically without additional interaction by the operator if a shock is advised.

When connected to a patient who is unconscious and not breathing, the DDU-120 AED performs the following tasks:

- Prompts the operator to take necessary actions to enable analysis.
- Automatically analyzes the patient’s ECG.
- Determines whether a shockable rhythm is present.
- Charges the capacitor.
- Automatically delivers a shock, without any user intervention, once the device has determined a shock is advised.
- Repeats the process, if needed.

The AED uses two self-adhesive, single-use, non-sterile defibrillation pads to monitor ECG signals and, if advised, to deliver defibrillation energy to the patient. These pads (also known as electrode pads or electrodes) are provided in a single-use, disposable package that can be preconnected to the AED. The pads package is labeled with an expiration date.

The AED determines proper pad-to-patient contact by monitoring the impedance between the two pads. Visual and audio prompts inform the operator of possible problems with patient contact. Voice prompts and visual LED indicators communicate the status of the AED and of the patient to the operator.

Defibrillation energy is delivered as an impedance compensated biphasic truncated exponential waveform. The device delivers 150 Joules into a 50-ohm load when using adult pads or when using attenuated child / infant pads, 50J of defibrillation energy into a 50-ohm load. Energy delivered does not change significantly with patient impedance, although the duration of the generated waveform will vary. The DDU-120 AED is designed to deliver up to 150J of defibrillation energy through a patient impedance range of 25 – 180 ohms or 50J of defibrillation energy when using the child / infant pads.

Defibrillation and AED operating power is supplied with a replaceable (non-rechargeable) lithium battery pack that provides for long standby life and low maintenance operation. Battery packs are available in several configurations optimized for use in specific applications. Each pack is marked with an expiration date.

The AED records event documentation internally and, optionally, on a Defibtech Data Card (DDC). The optional DDC inserts into a slot in the AED and enables the AED to record event documentation, and audio (audio enabled cards only) if sufficient space is available on the card. Audio recording is available only for units with installed audio-enabled Defibtech Data Cards. Event documentation stored internally can be downloaded onto a DDC for review.

1.2 The Defibtech DDU-120 AED

- A. **Speaker.** The speaker projects the voice prompts when the AED is on. The speaker also emits a “beep” when the unit is in standby mode and has detected a condition that requires operator attention.
- B. **SHOCK Required Indicator.** LED indicator that flashes when a shock is recommended and the unit has charged and is to deliver a shock is in the SHOCK button location. **Do not touch the patient while this indicator is flashing.**
- C. **“analyzing” LED (Light Emitting Diode).** This green LED flashes when the AED is analyzing the patient’s ECG rhythm.
- D. **“do not touch patient” LED.** This red LED flashes when the AED detects motion or other interference that prevents analysis of the signal or when the user should not be touching or moving the patient.
- E. **“check pads” LED.** This red LED flashes when the AED detects that the pad connection to the patient is poor or pads are not applied.
- F. **ON/OFF button.** Push button to turn the AED on. Push again to disarm and turn the AED off.
- G. **Pads connector port.** Insert Patient Pads Connector (item O) into this port to connect pads to the AED.
- H. **Battery pack.** The battery pack provides a replaceable main power source for the AED.
- I. **Battery pack opening.** Insert the battery pack firmly into this opening until the latch clicks into place.

- J. Battery pack eject button.** This button releases the battery pack from the AED. To remove the battery pack, push the button until the battery pack is partially ejected from the unit.
- K. Active Status Indicator (ASI).** The ASI indicates the current status of the AED. This indicator flashes green to indicate the unit has passed its last self-test and is ready for use. It flashes red to indicate unit needs attention from the user or needs servicing.
- L. Patient pads.** The defibrillation pads that are placed on the patient. The pads should be stored in the pad storage area on the back of the unit.
- M. Defibtech Data Card (DDC).** This optional plug-in card provides enhanced storage capabilities to the AED.
- N. Active Status Indicator (ASI) battery.** This 9V lithium battery provides power to the Active Status Indicator (ASI). It is inserted into a compartment in the battery pack.*
- O. Patient pads connector.** Insert into Pads Connector Port (item G) to connect pads to the AED.

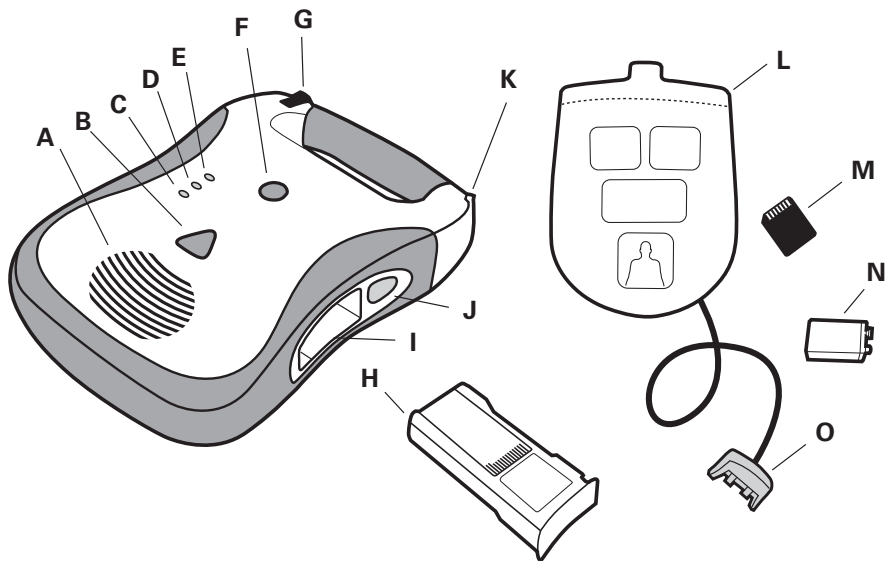

*DDU-120 AEDs will continue to perform standby and ASI functions without the 9V ASI battery installed, but battery pack standby life will be reduced.

1.3 Indications

The DDU-120 Automated External Defibrillator (AED) is indicated for use on victims of sudden cardiac arrest (SCA) who are:

- Unconscious and unresponsive
- Not breathing or not breathing normally

For patients under 8 years old, or weighing less than 55 lbs (25 kg), use child/infant defibrillation pads, if available. Do not delay therapy to determine exact age or weight. Apply the pads as shown for a child/infant and use the AED.

Federal Law (USA) restricts this device to sale by or on the order of a physician.

1.4 Contraindications

None.

1.5 Operator Training Requirements

In order to safely and effectively operate the DDU-120 AED, a person shall have met the following requirements:

- Defibtech DDU-120 AED and/or defibrillation training as required by local, state, provincial, or national regulations.
- Any additional training as required by the authorizing physician.
- Thorough knowledge and understanding of the material presented in this User Manual.

2 Dangers, Warnings, and Cautions

This chapter includes a list of danger, warning, and caution messages that relate to the Defibtech DDU-120 AED and its accessories. Many of these messages are repeated elsewhere in this User Manual and on the DDU-120 AED or accessories. The entire list is presented here for convenience.

2.1 DANGERS:

Immediate hazards that will result in serious personal injury or death.



Hazardous electrical output. This equipment is for use only by qualified personnel.



Possible fire or explosion. Do not use in the presence of flammable gases or anesthetics. Use care when operating this device close to oxygen sources (such as bag-valve-mask devices or ventilator tubing). Turn off gas source or move source away from patient during defibrillation, if necessary.



The DDU-120 AED has not been evaluated or approved for use in hazardous locations as defined in the National Electric Code standard. In compliance with IEC classification, the DDU-120 AED is not to be used in the presence of flammable substance/air mixtures.

2.2 WARNINGS:

Conditions, hazards, or unsafe practices that may result in serious personal injury or death.



Improper use can cause injury. Use the DDU-120 AED only as instructed in the User Manual and Operating Guide. The DDU-120 AED delivers electrical energy that can potentially cause death or injury if it is used or discharged improperly.



Improper maintenance can cause the DDU-120 AED not to function. Maintain the DDU-120 AED only as described in the User Manual. The AED contains no user-serviceable parts — do not take the unit apart.

Warnings (continued)



WARNING

No modification of this equipment is allowed.



WARNING

Electrical Shock Hazard. Dangerous high voltages and currents are present. Do not open unit, remove cover (or back), or attempt repair. There are no user serviceable components in the DDU-120 AED. Refer servicing to qualified service personnel.



WARNING

Lithium metal battery packs are not rechargeable. Any attempt to recharge a lithium metal battery pack may result in fire or explosion. Do not attempt to recharge the primary battery pack or lithium 9V battery.



WARNING

Do not immerse battery pack in water or other liquids. Immersion in fluids may result in fire or explosion.



WARNING

Do not attempt to recharge, short-circuit, puncture, or deform battery. Do not expose battery to temperatures above 50°C (122°F). Remove battery when depleted.



WARNING

Do not let fluids get into the DDU-120 AED. Avoid spilling fluids on the AED or its accessories. Spilling fluids into the DDU-120 AED may damage it or cause a fire or shock hazard.



WARNING

Do not sterilize the DDU-120 AED or its accessories.



WARNING

Use only Defibtech disposable self-adhesive defibrillation pads, battery packs, and other accessories supplied by Defibtech or its authorized distributors. Substitution of non-Defibtech approved accessories may cause the device to perform improperly.

Warnings (continued)



Do not open sealed pads package until pads are to be used.



Do not touch the patient during defibrillation. Defibrillation current can cause operator or bystander injury.



Do not allow pads to touch metal objects or equipment in contact with the patient. Do not touch equipment connected to the patient during defibrillation. Disconnect other electrical equipment from the patient before defibrillation.



Do not shock with defibrillation pads touching each other. Do not shock with gel surface exposed.



Do not allow defibrillation pads to touch each other, or to touch other ECG electrodes, lead wires, dressings, transdermal patches, etc. Such contact can cause electrical arcing and patient skin burns during defibrillation and may divert defibrillating energy away from the heart.



The defibrillation pads are intended for one-time use only and must be discarded after use. Reuse can lead to potential cross infection, improper performance of the device, inadequate delivery of therapy, and/or injury to the patient or operator.



Avoid contact between parts of the patient's body and conductive fluids such as water, gel, blood or saline, and metal objects, which may provide unwanted pathways for defibrillating current.



Disconnect all non-defibrillator proof equipment from the patient before defibrillation to prevent electrical shock hazard and potential damage to that equipment.



WARNING

Aggressive or prolonged CPR to a patient with defibrillation pads attached can cause damage to the pads. Replace the defibrillation pads if they become damaged during use.



WARNING

Possible Radio Frequency (RF) interference from RF devices such as cellular phones and two-way radios can cause improper AED operation. Normally using a cell phone near the AED should not cause a problem; however, a distance of 2 meters (6 feet) between RF devices and the DDU-120 AED is recommended.



WARNING

CPR during analysis can cause incorrect or delayed diagnosis by the patient analysis system.



WARNING

Do not place adult defibrillation pads in the anterior-posterior (front-back) position. A shock or no shock decision may be inappropriately advised. The DDU-120 AED requires that the adult defibrillation pads be placed in the anterior-anterior (front-front) position.



WARNING

Some very low amplitude or low frequency rhythms may not be interpreted as shockable VF rhythms. Also some VT rhythms may not be interpreted as shockable rhythms.



WARNING

Handling or transporting the patient during ECG analysis can cause incorrect or delayed diagnosis, especially if very low amplitude or low frequency rhythms are present. If the patient is being transported, stop vehicle before beginning ECG analysis.



WARNING

In patients with cardiac pacemakers, the DDU-120 AED may have reduced sensitivity and not detect all shockable rhythms. If you know the patient has an implanted pacemaker, do not place electrodes directly over an implanted device.



WARNING

During defibrillation, air pockets between the skin and defibrillation pads can cause patient skin burns. To help prevent air pockets, make sure self-adhesive defibrillation pads completely adhere to the skin. Do not use dried out or expired defibrillation pads.



User-initiated and automatic self-tests are designed to assess the DDU-120 AED's readiness for use. However, no degree of testing can assure performance or detect abuse, damage, or a defect that occurred after the most recent test is completed.



Use of damaged equipment or accessories may cause the device to perform improperly and/or result in injury to the patient or operator.



In the event the voice prompts cannot be heard for any reason (e.g. noisy environment), follow the LEDs on the front of the AED to complete the rescue.

2.3 CAUTIONS:

Conditions, hazards, or unsafe practices that may result in minor personal injury, damage to the DDU-120 AED, or loss of data.



Follow all battery pack labeling instructions. Do not install battery packs after the expiration date.



Follow all defibrillation pad label instructions. Use defibrillation pads prior to their expiration date. Do not re-use defibrillation pads. Discard defibrillation pads after use (in the event of suspected pad malfunction, return pads to Defibtech for testing).



The defibrillation pads should not be in continuous contact with the patient's skin for more than 24 hours.



Recycle or dispose of lithium battery packs in accordance with local, state, provincial, and/or national regulations. To avoid fire and explosion hazard, do not burn or incinerate the battery pack. Do not crush.

Cautions (continued)



Use and store the DDU-120 AED only within the range of environmental conditions specified in the technical specifications.



If possible, disconnect the DDU-120 AED from the patient prior to use of other defibrillators.



Using non-Defibtech Data Cards (DDC cards) may damage the unit and will void the warranty.



Although the DDU-120 AED is designed for a wide variety of field use conditions, rough handling beyond specifications may result in damage to the unit.





Federal Law (USA) restricts this device to sale by or on the order of a physician.

3 Setting Up the DDU-120 AED

This chapter describes the steps required to make your Defibtech DDU-120 AED operational. The DDU-120 AED is designed to be stored in a “ready” state. This chapter tells you how to make the device ready, so that if and when you need it, few steps are required to begin using the device.

3.1 Overview

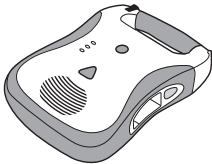
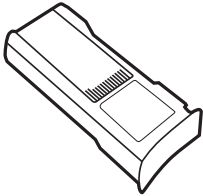
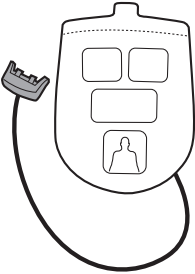
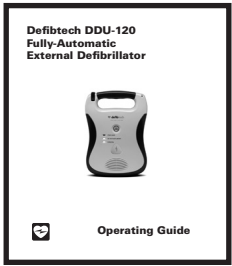
The following components and accessories are included with your DDU-120 AED. Replacement and other accessories are detailed in the “DDU-120 AED Accessories” section. Before getting started, identify each component and ensure that your package is complete.

<ul style="list-style-type: none">• DDU-120 AED 	<ul style="list-style-type: none">• Battery pack 
<ul style="list-style-type: none">• Defibrillation pads package 	<ul style="list-style-type: none">• Operating Guide 
<ul style="list-style-type: none">• 9V lithium battery 	<ul style="list-style-type: none">• Data Card <i>(included with some AED packages; also available separately - see Section 6.3)</i> 

3.2 Installing the Defibtech Data Card (“DDC”)

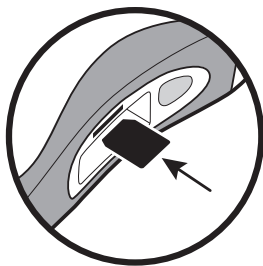

The Defibtech Data Card (“DDC”) is used to store event and audio information collected by the AED. All DDU-120 AEDs will operate without DDCs and will still store select event information internally. Different DDC versions store different amounts of information. DDCs are available in versions that store and don’t store audio information. Refer to the DDC technical specification for exact storage capabilities. Information stored on the DDC is retrievable with a separate PC-based software package (see Chapter 7).

To install the DDC, remove the battery pack and push the DDC, label side up, into the thin slot in the side of the AED centered over the battery pack opening. The card should click into place and be flush with the surface of the slot. If the card does not push in all the way, it may have been inserted upside down. In that case, remove the card, flip it over and try inserting it again.

To remove the DDC, press the card in all the way and then let go. The DDC will be partially ejected and can be removed by pulling it the rest of the way out.

3.3 Installing the Active Status Indicator 9V Battery

A user-replaceable lithium 9V battery, located inside the battery pack, provides Active Status Indicator (“ASI”) power (see Section 4.2 for details). This auxiliary battery is used to provide standby indicator power independently of the main lithium battery (contained in the battery pack) allowing the main battery pack to have a significantly longer shelf and standby life.

To meet battery pack specifications (see Section 8.2 for details), a lithium 9V battery should be installed into the battery pack. While DDU-120 AEDs will operate rescue and standby functions with a battery pack that does not contain 9V battery, battery pack standby life will be reduced.

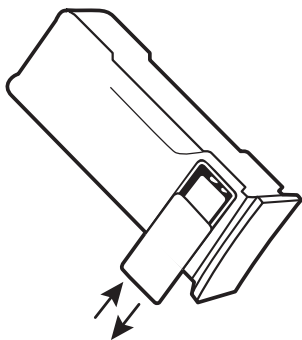

The 9V battery is installed into the battery pack in the 9V battery compartment. To install, remove the cover covering the 9V battery compartment by pushing on it sideways. The cover will slide and detach from the battery pack. Insert the 9V battery into the 9V battery compartment so that the contacts on the battery touch the contacts in the battery pack. Replace the 9V battery compartment door by placing it in the almost closed position and then sliding it closed. Only a fresh 9V lithium battery should be used as a replacement. Refer to the Maintenance section for more information on replacement batteries.

Once the battery pack is installed into the unit, the AED’s Active Status Indicator should flash green every five seconds.

3.4 Installing and Removing the Battery Pack

NOTE: DDU-120 AEDs will continue to perform standby and ASI functions without the 9V ASI battery installed, but battery pack standby life will be reduced.

The lithium battery pack provides power to the DDU-120 AED. Before inserting the battery pack into the AED, the 9V lithium battery should be installed in the battery pack itself as described in the previous section. Do not install the battery pack after the expiration date printed on the label. The battery pack is non-rechargeable.

To insert the battery pack into the AED, orient the battery pack so that the label faces up. Make certain that the battery opening in the side of the AED is clean and clear of any foreign objects. Insert the battery pack into the opening in the side of the AED. Slide the battery pack all the way in until the latch clicks. If it does not slide all the way in, it is most likely inserted upside down. Once fully inserted, the battery pack surface should be flush with the side of the AED.

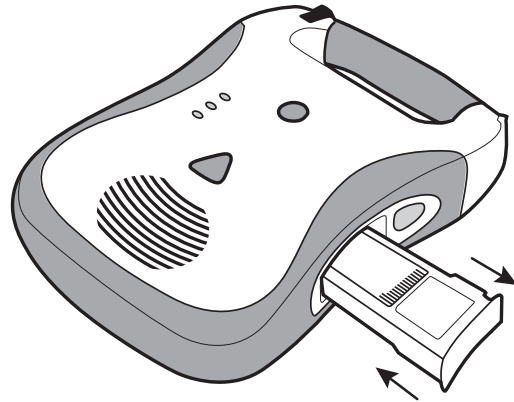

To remove the battery pack, push the battery eject button on the side of the AED. After the battery pack is partially ejected, pull the battery pack out.

Within moments of insertion, the AED will turn on and run a battery pack insertion self-test. The unit will automatically shut off after the test is run. Afterwards, the Active Status Indicator on the top corner of the AED will periodically flash. If the indicator flashes green, the AED and battery pack are functioning properly, if the indicator flashes red, there is a problem. Refer to Section 4.2 for more details on the meaning of the indicator.

3.5 Connecting the Pads

The defibrillation pads are supplied sealed in a pouch with the connector and part of the cable exposed.

Caution: DO NOT remove the defibrillation pads from the sealed package until the pads are to be used. The packaging should be opened only immediately prior to use, otherwise the pads may dry out and become non-functional.

Note: The AED is designed to be stored with the pads connector already installed. This reduces the time needed to set up and start treatment in an emergency.

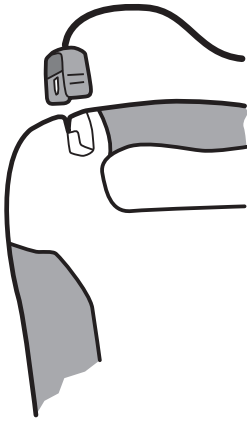

First, check to ensure that the pad package has not expired. Pads past their expiration date should not be used and should be discarded.

Insert the connector end of the defibrillation pad cable into the pads connector port on the top-left corner of the AED as shown at left. Insert the pads connector firmly until it is fully seated in the unit.

The connected pad package should then be stored in the pad storage slot in the back of the AED. After connecting the pads connector to the unit, push the pad package, with the pictures on the package facing out, rounded end first, into the pad holder compartment on the back of the AED. When the pad package is fully inserted, press the pad cable into the groove in the back of the unit to hold it in place and tuck any excess cable behind the pad package.

Caution: The pads are intended for one time use only and must be discarded after use or if the package has been opened.

3.6 Performing Manually-Initiated Self-Tests

Upon initial setup, perform a manually-initiated Self-Test as described in the following paragraph.

To perform a manual Self-Test, begin with the unit powered off. Press **and hold** the ON/OFF button until the unit announces that it is performing a Self-Test – this should take approximately 5 seconds. Once you hear the announcement, release the ON/OFF button and follow the AED's spoken instructions until the test is complete. The unit will run a series of internal tests, including charge and shock tests. The manually initiated Self-Test can be aborted by pressing the ON/OFF button again to turn the unit off. When the Self-Test is complete, the unit will announce its status and power off.

If the Self-Test passes: The unit will announce “AED OK” and power off. The unit may then be immediately used by pressing the ON/OFF button again.

If the Self-Test fails: The unit will announce the symptom. The user should refer to the “Troubleshooting” section in Chapter 5 of this manual for appropriate action.

Note: Every time the manually initiated Self-Test is run, the unit does an internal shock test. This test reduces the capacity of the battery pack by one shock.

In addition, the unit runs a Battery Pack Insertion Self-Test to test the battery pack. When the test is completed, the unit reports the status of the battery pack and powers off. The unit may then be immediately used by pressing the ON/OFF button again.

3.7 Storing the AED

The AED should be stored with pads attached in environmental conditions within range of the specifications (refer to the “Environmental” section of “Technical Specifications”). The unit should also be stored so that the Active Status Indicator can be readily seen.

The Active Status Indicator should periodically blink with a green light. If it blinks with a red light or does not blink at all, the AED needs servicing (refer to Section 4.2 for more information).

Defibtech recommends storing your AED in an easily-accessible location where the unit can be seen and heard.

4 Using the DDU-120 AED

This chapter describes how to use the DDU-120 AED. The AED was designed for simple operation, allowing the operator to focus on the patient. Concise and easily understandable voice prompts and visual (LED) indicators guide the operator through the use of the unit.

The basic steps for use are:

- Turn the AED ON by pressing the ON/OFF button.
- Connect pads to AED if not yet connected.
- Place pads on patient (follow instructions on pad package).
- Follow voice prompts.

4.1 Overview

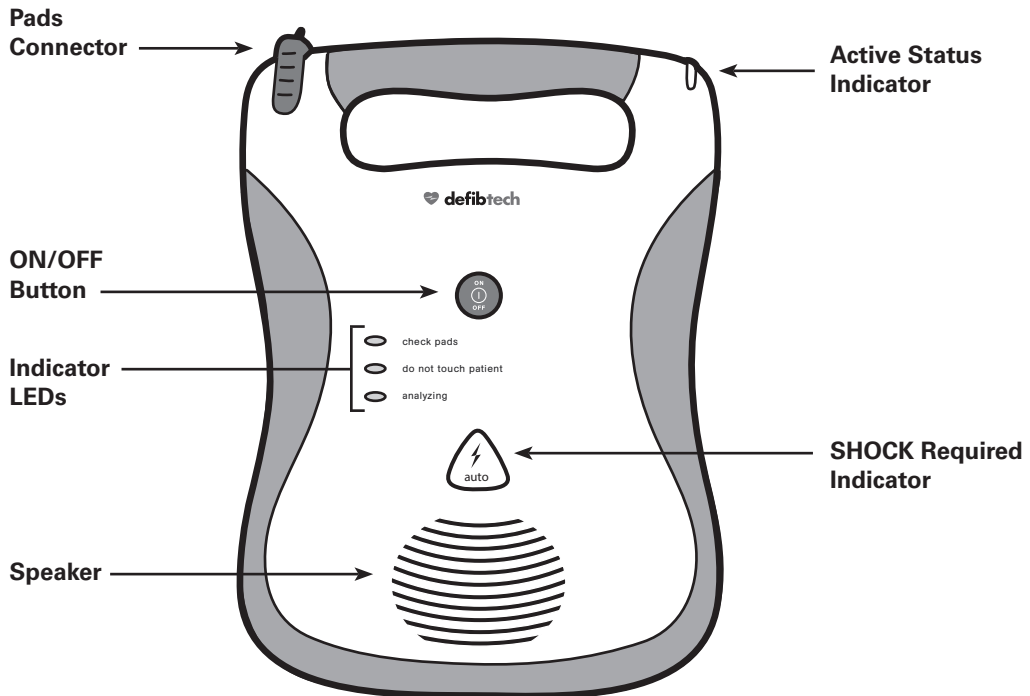

4.2 Checking the AED Status

Once a fully-functional battery pack is installed in the AED, an LED indicator located in the corner of the unit actively indicates unit status. If the unit is fully operational, the Active Status Indicator (“ASI”) will blink green and if the unit needs attention, the ASI will blink red. When the ASI blinks red, the unit will also “beep” periodically to call attention to itself.

To meet battery pack specifications (see Section 8.2 for details), a lithium 9V battery should be installed into the battery pack. While DDU-120 AEDs will operate rescue and standby functions with a battery pack that does not contain 9V battery, battery pack standby life will be reduced.

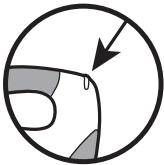
	ACTIVE STATUS INDICATOR	<ul style="list-style-type: none">• Off: Battery pack not installed or the AED is defective. Install a functional battery pack in the AED.• Steady-on green: The AED is ON and operating normally.• Blinking green: The AED is OFF and ready to operate normally.• Blinking red: The AED is OFF and the AED or battery pack needs attention.
---	--------------------------------	---

4.3 Turning on the AED

Press the ON/OFF button to turn the AED on. The unit will emit a “beep” and all the LEDs will light up temporarily. The ON/OFF button will illuminate green anytime the AED is on. Voice prompts will guide the operator in the use of the unit. To turn the unit off, press the ON/OFF button for approximately two seconds. The Active Status Indicator (“ASI”) will indicate the state of the unit.

	ON-OFF/ DISARM	<ul style="list-style-type: none">• ASI off or blinking: The AED is OFF. Press the green ON/OFF button to turn the AED ON.• ASI on (green): The AED is ON. Press the green ON/OFF button for approximately two seconds to turn the AED OFF.
---	-----------------------	--

4.4 Preparation

4.4.1 Call for Help

As soon as the AED is turned on the unit will prompt the user to “Call for Help”. This indicates that the first step in a rescue should always be to contact professional emergency services.

If another person is available, the user should direct that person to call for help and then continue the rescue without delay.

4.4.2 Preparing the Patient

Prepare the patient by removing any clothing from the patient’s chest. Wipe away moisture from the chest if necessary (the defibrillation pads will stick better on dry skin). If necessary, shave excessive chest hair, which can prevent effective patient-pad contact. To ensure that electrode pads fully contact the patient’s skin, check that no jewelry or other objects are directly underneath where the pads will be placed.

4.4.3 Opening the Pad Package

Remove the pad package from the pad storage slot at the back of the AED. Open the pad package by tearing along the dotted line, starting at the black arrow (follow directions on the package). Pull the protective backing from the pads and check that the pads are:

- Free from obvious signs of damage.
- Clean of excessive debris (for example, dirt if the pad was dropped).
- Not dried out, and that the gel is sticky and will adhere to the patient.
- Not expired. Do not use pads after the expiration date printed on the package.

If any of these conditions is found, use a new set of pads.

4.4.4 Connecting the Defibrillation Pads to the AED

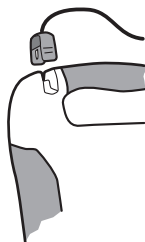

The DDU-120 AED is designed to be stored with the defibrillation pads connector attached to the unit, while the pads themselves remain sealed in their package. This reduces the time needed to set up and start treatment in an emergency.

The AED should be stored with the pads connector plugged into the unit. However, if pads were damaged or not properly connected, you may need to substitute a new set of pads during an emergency. The pads connector is on the top-left corner of the AED.

To remove an old set of pads, pull firmly on the pads connector. Do not reuse used pads. Insert the connector for the new pads as shown. The connector will only fit in one way – if the connector does not fit, rotate the connector before trying again. Insert connector firmly until it is completely seated in the unit.

If not needed for immediate use, the pad package can then be stored in the pad storage slot in the back of the AED. After connecting the pads connector to the unit, push the pad package, with the pictures on the package facing up and out, rounded end first, into the pad holder compartment on the back of the AED. When the pad pack is fully inserted, press the pad cable into the groove in the back of the unit to hold it in place and tuck any excess cable behind the pad package.

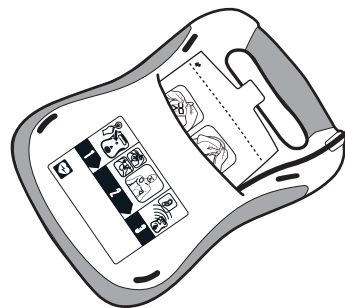

4.4.5 Applying Pads to the Patient

Follow this procedure to apply the defibrillation pads to the patient:

1. Tear the defibrillation pads package along the dotted line near the top of the package.
2. Remove the pads from the package and follow the directions and diagram showing proper pad placement located on the pads package.
3. Peel off the protective backing from one of the pads before placing it as shown on the diagram on the pad. Peel the backing off only when the pad is ready to be placed.
4. Place the pad with the sticky side of the pad on the patient's skin.
5. Repeat steps 3 and 4 to place the other pad onto the patient.

Correct pad placement (shown below) is essential for effective analysis of the patient's cardiac rhythm and subsequent shock delivery (if required). Pad placement on infants or children under 8 years or less than 55 pounds (25 kg) is different than placement for adults or children 8 years or older or over 55 pounds (25 kg). If you are unsure of the child's age or weight or do not have child/infant pads, do not delay treatment.

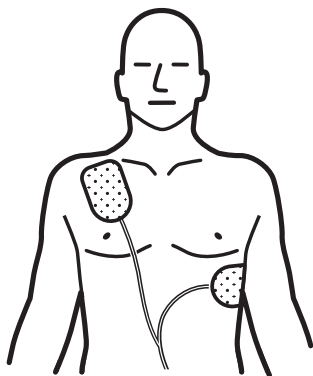

For adults and children 8 years or older or over 55 pounds (25 kg), use adult pads: Place one pad just below the patient's right collar bone as shown in the picture. Place the second pad over the ribs on the patient's left side below the left breast. Use picture on pad to determine individual pad placement.

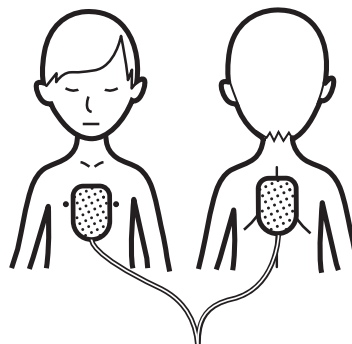

For infants and children under 8 years or less than 55 pounds (25 kg), use child/infant pads
(Note: Child/infant pads can be identified by their blue connector and pads package):

Place one pad in the center of the chest and one pad on the center of the back, as shown. Use picture on pad to determine individual pad placement.

4.4.6 Follow AED Prompts

At this point, the AED will check to make sure that the pads are well connected to the patient and that an adequate ECG signal is being received. Do not touch the patient, eliminate any patient movement, and cease CPR at this time.

If there is a problem with the pad connection, connector connection, patient motion or other interference, the AED will guide the operator with audible and visual prompts. Visual prompts consisting of flashing LEDs with associated labeling reinforce the audio prompts and aid in high ambient noise environments.

4.5 Heart Rhythm Analysis

Once the AED has determined that the pads are making a good connection to the patient, the AED will start the ECG rhythm analysis. The unit analyzes the ECG signal and determines whether a shockable or non-shockable rhythm is present. While analyzing, the AED will continue to monitor the pad connections and will abort analysis if it detects any pad problems. It will also continue to monitor for excessive motion or interference and will abort analysis if those conditions are detected.

4.6 Delivering the Shock

If the AED's ECG analysis algorithm has determined that a shock is advised, the unit will automatically charge in preparation for shock delivery. While the AED charges, the unit will continue to analyze the patient's heart rhythm. If the unit detects that the heart rhythm has changed to one with which a shock is not advised, the unit will abort the charging process and will prompt the user to begin CPR, if needed, for a period of two minutes. Also while charging, the AED will continue to monitor the pad connections and will abort charging if it detects any pad problems. It will also continue to monitor for excessive motion or interference and will abort charging if such conditions are detected. The user can abort charging or shock delivery at any time by pressing and holding the ON/OFF button for approximately two seconds to turn the unit off.

4.7 No Shock Required

If the AED's ECG analysis algorithm has determined that a shock is not advised, it will not charge the unit. If needed, the operator will be prompted to begin CPR. During CPR, the AED will not monitor the patient's ECG rhythm and will not advise the user to "stop motion" even if motion is present. Throughout the CPR period, the unit will announce time remaining in 15-second intervals. At the end of the CPR period, the unit will enter analysis mode.

4.8 Post-Shock CPR

After the AED has delivered a shock, the unit will require a mandatory CPR period. No patient ECG rhythm monitoring will occur during this period. Once the CPR period is complete, the AED will continue in analysis mode.

4.9 Post-Use Procedures

After the AED has been used on a patient, the unit should be cleaned following procedures in the "Cleaning" section and prepared for the next use. The following steps should be performed:

- Remove battery pack.
- Remove DDC if installed. Replace with a new DDC.
- Reinsert battery pack. Check that the Battery Pack Insertion Self-Test passes.
- Connect a new pad package (check to make sure the package is not expired).
- Hold ON/OFF button down for at least five seconds to initiate a manually initiated Self-Test. Unit will report status of the Self-Test and shut off.
- Check to make sure that the Active Status Indicator is flashing green.

4.10 AED Voice Prompts

4.10.1 General Prompts

<i>“Call for help”</i>
<i>Purpose:</i> As soon as the AED is turned on, the user will be prompted to call for help. This indicates that the first step in a rescue should always be to contact professional emergency services. If another person is available, the user should direct that person to call for help and then continue the rescue without delay.
<i>“Powering off”</i>
<i>Purpose:</i> This informs the user that the unit is turning off.

4.10.2 Pad Connection/Pad Application-Related Prompts

<i>“Follow instructions to apply pads”</i>
<i>Purpose:</i> This instructs the user to follow the AED prompts in order to apply the pads to the patient.
<i>“Remove clothing from patient’s chest”</i>
<i>Purpose:</i> This instructs the user to remove all clothing from patient’s chest. Pads must be applied to the patient’s bare chest.
<i>“Locate pads package in back of AED”</i>
<i>Purpose:</i> This helps the user locate the pads in the pad storage area, which is located on the back of the unit.
<i>“Plug in pads connector”</i>
<i>Purpose:</i> The AED is unable to detect that the pads are plugged in. Check that the connector is fully inserted into the unit. If the pads are properly plugged in, continue to follow audio and visual instructions.
<i>“Tear open pads package”</i>
<i>Purpose:</i> This instructs the user to tear open the pads package on the dotted line on the top of the package. Once the package is open, the user will be able to remove the pads from inside the package.
<i>“Peel adhesive pads from blue liner”</i>
<i>Purpose:</i> This instructs the user to peel each pad from the blue liner before placing the pads on the patient. Peel the pads from the blue liner only when the pad is ready to be placed. Place the pads with the sticky side of the pad on the patient’s bare skin.

<i>“Apply pads to patient’s bare chest as shown”</i>
<i>Purpose:</i> The AED has determined that the pads are not placed on the patient or not properly applied. Place pads on the patient following instructions on the pads package. If the prompts continue, try replacing the pads with a new set.
<i>“Poor pad contact to patient”</i> <i>“Press pads firmly”</i>
<i>Purpose:</i> The pads are not making proper contact with the patient and the impedance is out of range for proper ECG analysis and shock delivery. Check that the pads are properly placed and fully adhering to the patient and that there are no air bubbles between the pads and the patient. If the pads are not sticking due to moisture, dry the patient. If the pads are not sticking due to excessive hair, shave or clip excessive chest hair. If the prompts continue, try replacing the pads with a new set.
<i>“Check pads”</i>
<i>Purpose:</i> The pads are making improper contact with the patient or touching each other and the impedance is out of range for proper ECG analysis and shock delivery. Check that the pads are not touching each other and that the patient is dry. If the prompts continue, try replacing the pads with a new set.
<i>“Pausing for CPR”</i>
<i>Purpose:</i> If too long a period of time has passed, the user should stop attempting to resolve problems with the pads and assess the condition of the patient. The user will be prompted to begin CPR.
<i>“Replace pads”</i>
<i>Purpose:</i> If another set of pads is available, replace the pads. Otherwise, check that the pads are properly placed and fully adhered to the patient. Make sure that the pads are not touching each other. If the pads are not sticking due to moisture, dry the patient. If the pads are not sticking due to excessive hair, shave or clip excessive chest hair.

4.10.3 Motion/Interference Prompts

<i>“Stop motion”</i>
<i>Purpose:</i> The AED has detected possible motion in the patient. Stop all patient motion, including CPR, in response to this prompt.
<i>“Stop interference”</i>
<i>Purpose:</i> The AED has detected interference on the ECG signal. Eliminate any radio or electrical sources of interference. Check the pads to make sure they are adhering properly to the patient. If the environment is very dry, minimize movement around the patient to reduce static discharges.
<i>“Pausing for CPR”</i>
<i>Purpose:</i> The user should stop attempting to resolve motion and/or interference problems and assess the condition of the patient. The user will be prompted to begin CPR.

4.10.4 Heart Rhythm Analysis Prompts

<i>“Analyzing heart rhythm”</i>
<i>“Analyzing”</i>
<i>Purpose:</i> The AED is actively analyzing the patient’s ECG signal. The AED will continue analyzing until it has determined whether a rhythm is shockable or non-shockable or if analyzing is interrupted for some reason.
<i>“Do not touch the patient”</i>
<i>Purpose:</i> The AED is trying to analyze the patient’s heart rhythm. The operator should not touch the patient. This prompt will be spoken at the beginning of the analysis period.
<i>“Analyzing interrupted”</i>
<i>Purpose:</i> The AED has determined that accurate ECG analysis is not possible and has ceased analyzing. The operator is prompted to resolve the problem (refer to Sections 4.10.2 and 4.10.3 for more information). Once the problem is resolved, the unit will enter analysis mode again.
<i>“No shock advised”</i>
<i>Purpose:</i> The AED has determined that a shock is not required. The unit will not charge. The user will be prompted to begin CPR.
<i>“Shock advised”</i>
<i>Purpose:</i> The AED has determined that a shock is recommended and the unit will begin charging in anticipation of delivering a defibrillation shock. Analysis will continue during this phase.

4.10.5 Shock-Related Prompts

<i>“Charging”</i>
<i>Purpose:</i> The AED has determined that a shock is recommended and is charging the unit in anticipation of a defibrillation shock. Analysis will continue during this phase. A tone may sound to indicate charging progress. If the unit detects a rhythm change to a non-shockable one, charging will abort and the user will be prompted to begin CPR.
<i>“Stand clear”</i>
<i>Purpose:</i> The AED is charging and the operator and others should stand clear of the patient. Analysis will continue during this phase. A tone may sound to indicate charging progress. If the unit detects a rhythm change to a non-shockable one, charging will abort and the user will be prompted to begin CPR.
<i>“Shocking in 3, 2, 1”</i>
<i>Purpose:</i> This indicates that the DDU-120 AED has fully charged, that the heart rhythm analysis algorithm still indicates a shock is recommended, and the unit is about to deliver a shock. The SHOCK Required Indicator will flash during this time. The shock will automatically be delivered after the count reaches “1.” <i>Do not touch the patient during this time.</i> Note: At any time during the charging process or after the AED has been charged, the operator may disarm the unit by pressing the ON/OFF button for approximately 2 seconds to power off the AED.
<i>“Shock ‘x’ delivered”</i>
<i>Purpose:</i> The AED has delivered the shock. The ‘x’ indicates the number of shocks that have been delivered since the unit was turned on. After each shock, the AED will enter Post-Shock CPR mode.
<i>“Shock cancelled”</i>
<i>Purpose:</i> The AED has aborted the shock. If the unit detects a rhythm change to a non-shockable rhythm, the unit will cancel the shock. Also, on the DDU-120 AED, if the SHOCK button is not pressed within 30 seconds of the initial “Press flashing SHOCK button” prompt, the unit will automatically cancel the shock.

4.10.6 No Shock Required Prompts

“No shock advised”

“It is safe to touch the patient”

Purpose: The AED has determined that a shock is not required. The unit will not charge or automatically deliver the shock. If the AED is charged, the shock will be canceled. The user will be prompted to begin CPR.

4.10.7 CPR Prompts

“Begin CPR now”

Purpose: This indicates that the user should begin performing CPR immediately. The unit will not monitor the patient’s ECG rhythm during this CPR period. The “analyzing” LED will remain off to indicate that background rhythm monitoring has been suspended.

“Give compressions”

Purpose: This indicates that the user should begin CPR compressions immediately. The unit will emit a beep at the rate that compressions should be given. The “analyzing” LED will remain off to indicate that ECG analysis has been suspended.

“Continue”

“Continue for 1 minute ‘x’ seconds”

Purpose: This indicates that the user should continue performing CPR. This phrase is spoken to let the user know that the unit is still operating normally. The unit will not be monitoring the patient’s ECG rhythm during this mandatory two minute CPR period. The “analyzing” LED will remain off to indicate that background rhythm monitoring has been suspended.

“Ending in 5, 4, 3, 2, 1”

Purpose: This indicates that the user should prepare to finish performing CPR. This phrase is spoken during the last several seconds of the CPR period to let the operator know that the unit is still operating normally and that the CPR period is ending. The “analyzing” LED will remain off to indicate that background rhythm monitoring has been suspended.

“Stop CPR”

“Stop now”

Purpose: This indicates that the CPR period has ended and the user should stop CPR.

4.11 LED Indicators

Indicator	Color	Meaning
"check pads" LED	Red	Lights when the defibrillation pads require attention.
"do not touch patient" LED	Red	Lights when the patient should not be touched.
"analyzing" LED	Green	Lights when the AED is analyzing heart rhythm.
"SHOCK Required" (auto) LED	Red	Flashes when the DDU-120 AED is about to automatically deliver a shock. <i>Do not touch the patient while this indicator is flashing.</i>
Power ON/OFF button	Green	Lights when the AED is powered on.
Active Status Indicator ("ASI")	Green or Red	Lights to indicate the operational status of the AED when in standby mode (see Section 4.2 for details).

4.12 Operational Environment

The DDU-120 AED is designed to operate in a wide range of environmental conditions. To ensure the reliability and safety of the AED in a given environment, refer to the "Environmental" section for a detailed list of approved environmental conditions.

5 Maintaining and Troubleshooting the DDU-120 AED

This chapter describes the maintenance and troubleshooting procedures for the DDU-120 AED. The Self-Tests that are automatically performed by the device are described along with recommended routine maintenance. A troubleshooting guide is provided to help diagnose user serviceable problems.

The DDU-120 AED contains no user serviceable parts except for the ASI 9V battery.

5.1 Self-Tests

Power-On Self-Tests are performed every time the unit is turned on to test the basic operation of the unit. The unit also performs daily, weekly, monthly and quarterly self-tests automatically to check the integrity of the unit's hardware and software.

Manually-initiated self-tests may be run at any time by the user to test the AED's systems, including the charging and shocking functions (the shock is internally dissipated and no voltage will be present at the pads).

Note: Every time the manually-initiated Self-Test is run, the unit does an internal shock test. This test reduces the capacity of the battery pack by one shock.

To perform a manual Self-Test, begin with the unit powered off. Press and hold the ON/OFF button until the unit announces that it is performing a Self-Test – this should take approximately 5 seconds. Once you hear the announcement, release the ON/OFF button and follow the AED's spoken instructions until the test is complete. The unit will run a series of internal tests, including charge and shock tests. The manually initiated Self-Test can be aborted by pressing the ON/OFF button again to turn the unit off. When the Self-Test is complete, the unit will announce its status and power off.

If the Self-Test passes: The unit will announce: "AED OK" and power off. The unit may then be immediately used by pressing the ON/OFF button again.

If the Self-Test fails: The unit will announce the symptom. The user should refer to the "Troubleshooting" section in Chapter 5 of this manual for appropriate action.

5.2 Routine Maintenance

The DDU-120 AED is designed to be very low maintenance. Simple maintenance tasks are recommended to be performed regularly to ensure its readiness (see sample maintenance table below). Different maintenance intervals may be appropriate depending on the environment where the AED is deployed, and ultimately the maintenance program is at the discretion of the emergency response program’s medical director.

Daily	Monthly	After Each Use	Action
●	●	●	Check that Active Status Indicator (ASI) is flashing green
	●	●	Check the condition of the unit and accessories
		●	Run manually-initiated self-test
		●	Replace pads
	●		Check pads and battery pack expiration dates
		●	Check the DDC, if one was installed

Note: If the unit has been dropped, mishandled, or abused, a manually-initiated self-test should be performed.

5.2.1 Checking the Active Status Indicator (“ASI”)

The Active Status Indicator (“ASI”) is located in the upper corner of the AED and indicates the operational readiness state of the unit. It will periodically flash green to indicate a fully functional condition. If it is flashing red or not flashing at all, the AED needs attention. Any time the ASI is flashing red, the unit will periodically emit a “beep” to call attention to itself.

If the ASI is not flashing at all, the most likely cause is that the battery pack is not operating and should be replaced. If it still does not flash after inserting a new battery pack, the DDU-120 AED is non-operational and needs servicing.

If the ASI is flashing red, turn the AED on. If the unit does not turn on or does not speak, the AED is non-operational and requires servicing. If the unit does turn on, the voice prompts will indicate the nature of the problem when the AED is powered off.

5.2.2 Maintenance-Related Prompts

"Power-on test failed" "Service code 'xxxx' "
<i>Purpose:</i> This indicates that the AED has failed the power-on self-test and may be non-operational and may require servicing. The code number will indicate to service personnel the type of problem the unit is experiencing.
"Battery test failed" "Service code 'xxxx' "
<i>Purpose:</i> This indicates that the AED's battery pack is non-operational and needs servicing. The code number will indicate to the service personnel the type of problem that the unit is experiencing.
"Service code 'xxxx' "
<i>Purpose:</i> The AED will report this message when it powers off, indicating a service code that was previously detected.
"Service required"
<i>Purpose:</i> This indicates that the AED has detected an internal error, is non-operational, and needs servicing.
"Battery low"
<i>Purpose:</i> This indicates that the battery pack capacity is low and that the battery pack should be replaced soon. The AED will still be able to deliver at least six defibrillation shocks the first time this message is spoken.
"Replace battery now"
<i>Purpose:</i> This indicates that the battery pack is almost discharged and that the AED may not be able to deliver defibrillation shocks. Replace the battery pack immediately.
"Unknown battery type"
<i>Purpose:</i> This indicates that the installed battery pack is not recommended for use with the AED (see Section 8.2 for details).
"Pads missing"
<i>Purpose:</i> This indicates that the unit did not detect connected pads during a self-test.

5.2.3 Checking the Condition of the AED and Accessories

Inspect the unit for cracks or other signs of damage on the case, as well as dirt or contamination, especially in the areas around the connector socket and battery pack opening.

If any cracks or other signs of damage are observed, remove the unit from service and contact an authorized service center.

If any dirt or contamination is observed, refer to the “Cleaning” section for guidance on cleaning your unit.

5.2.4 Replacing the Pads

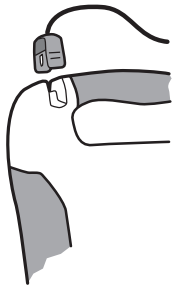

The defibrillation pads are intended for one time use only. The pads must be replaced after each use or if the package has been damaged.

The defibrillation pads are supplied in a sealed pouch with the connector and part of the cable exposed. The AED is designed to be stored with the electrode cable already installed. This allows the pads to be stored in a pre-connected state for rapid deployment during an emergency.

Caution: DO NOT remove the defibrillation pads from the sealed package until the pads are to be used. The packaging should be opened only immediately prior to use, otherwise the pads may dry out and become non-functional.

First, check to ensure that the pad package has not expired. Pads past their expiration date should not be used and should be discarded. Next, check to ensure that the pads package has not been torn, opened or damaged. Dispose of the pads if the package is open or damaged. Inspect the pads cable and replace if any nicks, cuts, or broken cables are found. Insert the connector end of the defibrillation pad cable into the pads connector port on the corner of the AED as shown. Press the pads connector in firmly until it is fully seated in the unit.



The pad package can then be stored in the pad storage slot in the back of the AED. After connecting the pads connector to the unit, push the pad package, with the pictures on the package facing up and out, rounded end first, into the pad holder compartment on the back of the AED. When the pad pack is fully inserted, press the pad cable into the groove in the back of the unit to hold it in place and tuck any excess cable behind the pad package.

Caution: The pads are intended for one time use only and must be discarded after use or if the package has been opened.

5.2.5 Checking Pad and Battery Pack Expiration Dates

It is important that the patient pads and the battery packs not be used past their expiration dates. The expiration date of the pad package is printed on the outside of the sealed package. The expiration date of the battery pack is printed on the label on the pack. The battery pack should be removed and replaced by this date; when the battery pack is used up, the unit will indicate “battery low” or “replace battery now” and the Active Status Indicator will flash red.

Once an accessory is past its expiration date, it should be replaced immediately. Follow the instructions in the “Installing and Removing the Battery Pack” and “Connecting the Pads” sections to replace the part with an unexpired part. Patient pads should be discarded. Battery packs should be appropriately recycled.

5.2.6 Checking the Defibtech Data Card

Each time the AED is used, an event file is created on the Defibtech Data Card (if installed). If the unit was used to treat a patient, the DDC in the unit should be removed and provided to the patient’s care provider. A new DDC should be installed before the next use.

To remove the DDC, first remove the battery pack by pressing the battery pack eject button on the side of the unit. The DDC card is located in a slot directly above the battery pack opening in the unit. To remove the DDC card, press the DDC in all the way and then release. The DDC will be partially ejected and can be removed by pulling it the rest of the way out. To install a new DDC, insert the DDC, label side up, in the thin slot on the top of the opening for the battery pack. The card should click into place and be flush with the surface of the slot. If the card does not push in all the way, it may have been inserted upside down. In that case, remove the card, flip it over and try inserting it again.

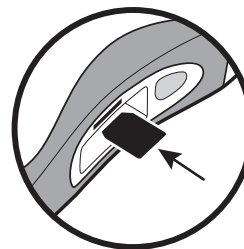

Note: A DDC is not required for the AED to operate. Even if a DDC card is not installed, relevant event information will still be recorded internally. The AED will still operate properly even after a “replace data card” message.

5.2.7 Checking the AED Software Version Number

To check what AED system software version number that any DDU-120 AED is running, perform the following procedure:

- Make sure a DDC card is not in the unit's data card slot (see section 5.2.6, "Checking the Defibtech Data Card").
- Power on the AED by pressing the ON/OFF button.
- After the unit turns on, press and hold the ON/OFF button (even after the unit powers off) for approximately 5 seconds until all LEDs flash and the unit says "data card missing" and then speaks the software version number.

IMPORTANT NOTE: This User Manual only applies to DDU-120 AEDs running software version 3.2 or higher that include the marking shown in the diagram at right on the rear panel AED pad holder label.

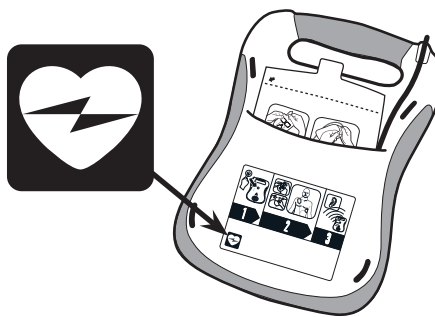

5.2.8 Running an Application from a Defibtech Data Card

To run an application from a Defibtech Data Card (DDC), perform the following procedure:

1. Press the orange battery pack eject button to eject the battery pack from the AED.
2. Insert the DDC card, notched end first and label side up, into the slot above the battery compartment (as shown in the illustration at right). The card will click into place and should be flush with the edge of the card slot.
3. Re-insert the battery pack back into the AED. The unit may perform a battery pack self-test and then power itself off.
4. Power the AED on by pressing and releasing the green ON/OFF button. The device will begin to speak and operate normally.
5. With the unit on, press **and continue to hold** the green ON/OFF button down until the AED automatically restarts and begins executing the application on the DDC card. Voice prompts and cycling status lights will indicate that the application is running. Release the ON/OFF button at this time. When the card application has been fully executed, the AED may automatically power itself off or need to be powered off by the user. For example, if the DDC card contains a software upgrade, the AED will announce "Performing AED Upgrade" and the status lights will cycle throughout the upgrade process. When the upgrade is

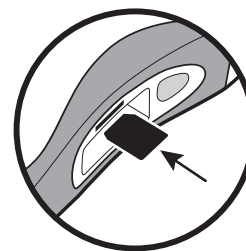

complete, the AED will announce “AED Upgrade Complete, Version X point X” where “X point X” is the software version number (i.e. “Version 3 point 2”). The unit should then be powered off by pressing the green ON/OFF button (**NOTE:** If the AED does not power off when the ON/OFF button is pressed, the upgrade is still in progress).

6. Be sure that the card application has been fully executed and that the AED is powered off. Eject the battery pack, remove the DDC card, and re-insert the battery pack. The AED may perform a battery pack self-test and then power itself off.
7. Verify that the Active Status Indicator (ASI) located on the top right corner of the AED is periodically flashing green. If it isn't (or if any other errors are encountered while performing this procedure), refer to the Section 5.7 (“Troubleshooting”).

5.3 Replacing the Active Status Indicator 9V Battery

The lithium 9V ASI battery is located in the battery pack in the 9V battery compartment (see figure).

To install, remove the cover covering the 9V battery compartment by pushing on it sideways. The cover will slide approximately a 1/4 inch and then can be detached from the battery pack. Insert the 9V battery into the 9V battery compartment so that the contacts on the battery touch the contacts in the battery pack. Replace the 9V battery compartment door by reversing the process used to remove the door.

Once the battery pack is installed into the unit, the AED's status indicator should periodically flash green.

Note: The unit will operate without a 9V battery installed, but battery standby life will be reduced.

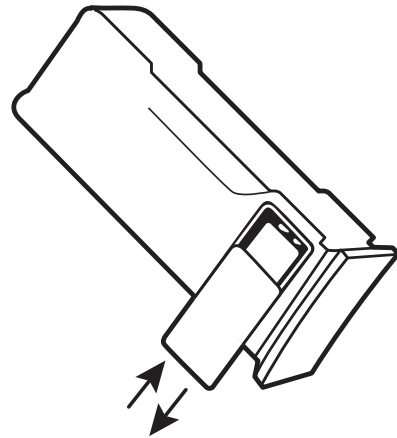

5.4 Cleaning

Periodically clean the AED of any dirt or contaminants on the case and connector socket. The following are important guidelines to be adhered to when cleaning the device:

- The battery pack should be installed when cleaning the AED.
- Do not immerse the AED in fluids or allow fluids to enter the unit. Use a soft cloth to wipe the case clean.
- Do not use abrasive materials or strong solvents such as acetone or acetone based cleaning agents. The following cleaning agents are recommended for cleaning the AED case and the connector socket:
 - » Soapy water
 - » Ammonia based cleaners
 - » Hydrogen peroxide
 - » Isopropyl alcohol (70 percent solution)
 - » Chlorine bleach (30 ml / liter water)
- Ensure that the connector socket is completely dry before reinstalling the pads cable. After cleaning the device and before returning it to service, always turn the unit on for a few seconds, which will cause the unit to run a standard Power-On Self-Test.

Please note that none of the items provided with the DDU-120 AED (including the AED itself) are sterile or require sterilization.

Warning: Do not sterilize the DDU-120 AED or its accessories.

5.5 Storage

The AED should be placed in a readily-accessible location in an orientation where the Active Status Indicator in the upper corner of the unit can be easily seen and heard. In general, the unit should be stored in clean, dry and moderate temperature conditions. Make sure that the environmental conditions of the storage location are within the ranges detailed in the “Environmental” section.

5.6 Operator's Checklist

The following checklist may be used as the basis for an Operator's Checklist. The table should be copied and filled out as recommended by the schedule in the "Routine Maintenance" section. As each item is completed, it should be checked off.

Defibtech DDU-120 Operator's Checklist						
AED Serial Number: _____						
AED Location: _____						
Date:						
Check unit and accessories for damage, dirt and contamination. Clean or replace as necessary.						
Check that spare battery pack and pads available.						
Check that battery pack and pads not past expiration dates.						
Check that the Active Status Indicator (ASI) is flashing green.						
Comments:						
Inspection by: (initials or signature)						

5.7 Troubleshooting

The following table lists the common causes for problems, the possible cause, and the possible corrective actions. Refer to the other sections of the User Manual for detailed explanations on how to implement the corrective actions.

To have the unit report what the root cause of the problem is, power the AED on and then power it off by pressing the ON/OFF button for approximately two seconds. While powering off, the unit should issue a voice prompt that details the cause of the problem. Use the chart below to determine the appropriate corrective action based upon what prompt was spoken by the unit.

If the unit continues to be non-functional, contact Defibtech (see Chapter 10 for information).

Symptom	Possible Cause	Corrective Action
Unit will not turn on	Battery pack not inserted	Insert battery pack
	Battery pack depleted or needs servicing	Replace battery pack or call for service
	Unit needs servicing	Call for service
Unit immediately turns off	Battery pack depleted	Replace battery pack
	Unit needs servicing	Call for service
ASI flashes red and/or unit makes periodic "beep" sound	Unit may need servicing	Power unit on and then power off by pressing ON/OFF button for approximately two seconds; note problem indicated by voice prompt and, if necessary, call for service
	Battery pack non-functional	Replace battery pack
	Defibrillation pads are not pre-connected to unit	Connect defibrillation pads to unit
ASI does not flash at all while unit is in standby (powered off)	Battery pack not inserted	Insert battery pack
	Battery pack is low or needs servicing	Replace battery pack or call for service
	Unit needs servicing	Call for service
"Power on test failed, service code 'xxx'" prompts	Unit needs servicing	Record code number and call for service
"Battery test failed, service code 'xxx'" prompts	Battery pack needs servicing	Record code number and replace with new battery pack
"Service required" prompt	Unit needs servicing	Call for service
"Replace battery now" prompt	Battery pack capacity is critically low	Unit may not deliver a shock, replace battery pack immediately

Symptom	Possible Cause	Corrective Action
“Battery low” prompt	Battery pack capacity is getting low	Replace battery pack as soon as possible
“Unknown battery type” prompt	Battery pack not recommended for use with unit (see Section 8.2)	Replace installed battery pack with recommended battery pack
“Pads missing” prompt	Pads not connected	Make sure pads connector is oriented correctly and fully inserted into unit
“Plug in pads connector” prompt	Pads connector not plugged in	Plug in pads connector
	Pads connector broken	Replace pads
	Unit’s connector broken	Call for service
“Apply pads to patient’s bare chest as shown” prompt	Pads not connected to patient	Place pads on patient
	Pads not making good connection to patient	Check pad connection to patient
	Pads or pad cable damaged	Replace pads
“Poor pad contact to patient”; “Press pads firmly” or “Replace pads” prompt	Dry pads	Replace pads
	Partial pad connection	Check that pads are placed securely on patient
	Pads touching	Separate pads and place correctly on patient
“Check pads” prompt	Pads touching	Separate pads and place correctly on patient
“Stop motion” prompt	Patient motion has been detected	Stop patient motion
“Stop interference” prompt	External interference has been detected	Stop external interference
“Analyzing interrupted” prompt	Motion or interference detected	Stop motion or interference
“Shock cancelled” prompt	Patient’s ECG rhythm changed	No action necessary
	Low battery – insufficient to charge	Replace battery pack
	Hardware failure	Run manually initiated Self-Test, return unit for servicing
	Bad pad to patient connection	Check that pads are placed securely on patient
	Dry pads	Replace pads
“Replace data card” prompt	DDC card is full	Replace DDC card with a card that is not full
	DDC has failed	Replace DDC card

5.8 Repair

The DDU-120 AED contains no user serviceable parts except for the ASI 9V battery. If the unit needs servicing, contact Defibtech (see Chapter 10 for contact information).

6 DDU-120 AED Accessories

This chapter describes the components and accessories that can be used with the Defibtech DDU-120 AED. For contact information on obtaining replacement component parts and accessories, refer to Chapter 10 of this manual. For more information about accessories, please visit www.defibtech.com or contact Defibtech or your distributor.

6.1 Defibrillation Pads

The DDU-120 AED is used with Defibtech self-adhesive defibrillation pads for adults or with attenuated pediatric pads for infants and children. These pads serve two functions:

- Allow the unit to read the patient's electrocardiogram (ECG) rhythm.
- Deliver defibrillation energy to the patient when needed.

The Defibtech self-adhesive defibrillation pad assembly comes in a "leads-out" sealed package that allows the device to be stored with pads connected. When the AED is used, the operator needs only to remove the pad packaging, tear open the package and turn the device on to administer care. The AED has a storage area in the back of the unit that allows for storage of a single sealed pad package.

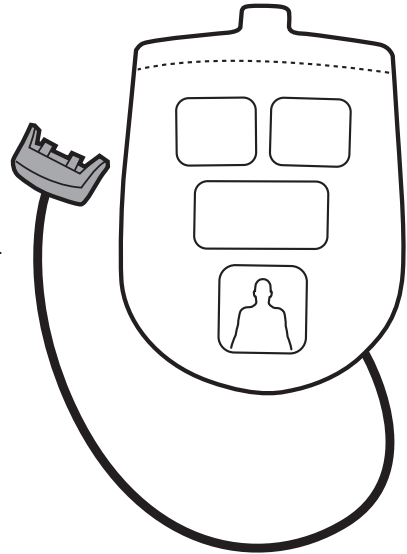

6.2 Battery Packs

The DDU-120 AED uses a lithium battery pack. The battery pack contains the main lithium battery cells and a 9V lithium battery. Different capacity battery packs are available. Refer to Section 8.2 for detailed information on the available packs. The battery pack is inserted into the battery pack opening on the side of the AED and latches into place.

The main battery is based on a lithium battery technology and provides the AED with a long shelf and standby life.

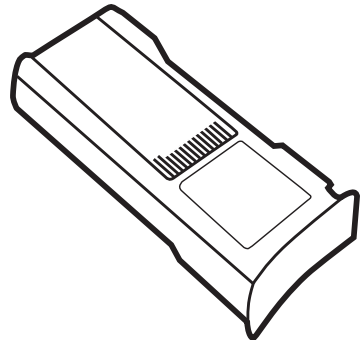

6.2.1 Active Status Indicator 9V Lithium Battery



The Active Status Indicator (“ASI”) battery is a 9V lithium battery. It provides power to the AED’s Active Status Indicator to prevent the main defibrillation battery from being depleted for non-essential functions. This provides a significantly longer standby life for the AED and battery pack and extends the lifetime during which the AED can deliver defibrillation shocks.

6.3 Defibtech Data Cards (“DDC”)

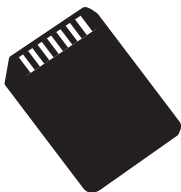

The DDU-120 AED is designed to use optional Defibtech Data Cards (“DDC”). The AED will operate with or without a DDC, but if a DDC is installed, additional event storage capacity is available.

The AED accepts DDC cards of different types (see Section 8.4 for details), each designed to record an assortment of data for a given period of time. For example, the AED can record up to 12 hours of ECG data only or approximately one hour and forty minutes of audio and ECG data on a single DDC card. Cards are available with and without audio logging enabled.

The DDC is inserted into a slot above the battery pack opening in the AED. A new and initialized DDC card should be used each time the AED is operated to maximize recording time. A new event file is created on the DDC each time the AED is turned on and the following information is recorded (DDC cards may contain a maximum of 255 event files):

- The time the AED was turned on.
- Other data such as: ECG data, time data, audio data (audio-enabled card only).
- Event milestones such as: motion detection, shock advice, shock delivery information.

When an audio-enabled DDC gets low on available storage, the AED will stop recording audio data to allow room for additional ECG data in an attempt to record at least one hour of ECG. Data from a previous event will NOT be erased. If the DDC fills completely, the AED will still be operable and select event documentation for the current session is still recorded internally.

Internally-recorded event information can be downloaded for external review by inserting a blank DDC card into the unit. The DDC slot is located just inside the battery pack opening. For instructions on how to install and remove a DDC card, refer to Section 3.2 (“Installing the Defibtech Data Card”) of this manual. To download data from the card, refer to Section 7.2 (“Downloading the Internal Data Log”).

6.4 Recycling Information

At the end of its useful life, recycle the defibrillator and its accessories.

6.4.1 Recycling Assistance

For recycling assistance contact your local Defibtech distributor. Recycle in accordance with local and national regulations.

6.4.2 Preparation

Items should be clean and contaminant-free prior to being recycled. When recycling used disposable electrodes, follow local clinical procedures.

6.4.3 Packaging

Packaging should be recycled in accordance with local and national requirements.

6.4.4 Notice to European Union Customers



The crossed-out wheeled bin symbol on this device indicates that this equipment has been put on the market after 13 August 2005, and is included in the scope of the directive 2002/96/EEC on Waste Electrical and Electronic Equipment (WEEE) and of the national decree(s), which transpose provisions of such directive.

At the end of its lifetime, this device can only be disposed of in compliance with the provisions of the above mentioned European directive (and as amended) as well as with the corresponding national regulations. Severe penalties are possible for unauthorized disposal.

Electrical and Electronic Equipment (EEE) may contain polluting components and hazardous substances the accumulation of which could pose serious risk for the environment and human health. It is for this reason that local Administrations provide regulations which encourage reuse and recycling, and prohibit the disposal of WEEE as unsorted municipal waste and require the collection of such WEEE separately (at specifically authorized treatment facilities). Manufacturers and authorized distributors are required to supply information about a safe treatment and disposition of the specific device.

You may also return this equipment to your distributor when purchasing a new one. As for reuse and recycling, notwithstanding the limits imposed by the nature and the use of this device, the manufacturer will do his best to develop recovery processes. Please contact the local distributor for information.

7 Event Viewing

This chapter includes information about DefibView, Defibtech Data Cards (DDC cards), and downloading internal data logs.

7.1 DefibView

DefibView is a Windows-based software application that reads data stored on a DDC card and displays the data on a personal computer. DefibView serves the following primary functions:

- Enables emergency care personnel to review a cardiac episode from the time the AED was turned on and connected to the patient until the unit is turned off.
- Provides maintenance personnel with additional parameter information to assist in troubleshooting a device suspected of malfunctioning.

DefibView is a stand-alone software application. DefibView cannot be used while the AED is in operation, and its function is solely to support post-event review.

Caution: DefibView is not intended for clinical use. Information presented by DefibView should not be used for making clinical decisions.

7.2 Defibtech Data Cards (DDC Cards)

If a DDC card is installed in the unit, every time the DDU-120 AED is turned on, the following information is recorded on a new file on the card:

- The time the AED was turned on.
- Other data such as: ECG data, time data, audio data (audio-enabled cards only), event milestones such as: motion detection, shock advice, shock delivery information..

This information can be reviewed using the DefibView application.

Caution: Using non-Defibtech Data Cards (DDC cards) may damage the unit and will void the warranty.

7.3 Downloading the Internal Data Log

Regardless of whether a DDC card is installed in the unit, select information is recorded internally within the DDU-120 AED. The information recorded is limited to:

- The time the AED was turned on.
- Other data such as event milestones (motion detection, shock advice, shock delivery information, etc).

Note: Audio data is not logged internally.

7.3.1 Downloading the Internal Data Log Using a DDC Card

To download the internally logged information, perform the following procedure:

- Insert a blank DDC into the unit.
- Turn the unit on.
- Once the unit is on, turn it off in data download mode by pushing and holding the ON/OFF button for at least five seconds.
- Allow the unit to write the contents of the internal log to the DDC by waiting for the unit to turn off automatically.

The AED will write the contents of the internal log onto the DDC card. This information can then be reviewed using the DefibView software.

8 Technical Specifications

8.1 Defibtech DDU-120 AED

8.1.1 General

Category	Specification
Size	8.5 x 11.8 x 2.7 inches (22 x 30 x 7 cm)
Weight	Approximately 4.2 lbs (1.9 kg) with DBP-1400 battery pack Approximately 4.4 lbs (2 kg) with DBP-2800 battery pack
Power	Battery pack (not rechargeable)
Design Standards	Meets applicable requirements of <ul style="list-style-type: none"> • IEC 60601-1 • UL 60601-1 • CAN/CSA C22.2 No.60601-1 • IEC 60601-1-2 • IEC 60601-2-4 • AAMI DF80
Device Classification	Internally powered with defibrillator-proof BF-type patient applied parts (per EN-60601-1)
Patient Safety	All patient connections are electrically isolated
Rescue Protocol	AHA/ERC (default); future protocols via field updates

8.1.2 Environmental

Category	Specification	
Operating / Maintenance	Temperature	0 – 50°C (32 – 122°F)
	One Hour Operating Temperature Limit (extreme cold)*	-20°C (-4°F)
	Humidity	5% – 95% (non-condensing)
Standby / Storage	Temperature	0 – 50°C (32 – 122°F)
	Humidity	5% – 95% (non-condensing)
Altitude	-150 to 4500 meters (-500 to 15,000 feet) per MIL-STD-810F 500.4 Procedure II	
Shock / Drop Abuse Tolerance	MIL-STD-810F 516.5 Procedure IV (1 meter, any edge, corner, or surface, in standby mode)	
Vibration	MIL-STD-810F 514.5 Category 20 RTCA/DO-160D, Section 8.8.2, Cat R, Zone 2, Curve G (Helicopter) RTCA/DO-160D, Section 8, Cat H, Zone 2, Curves B&R (Jet Aircraft)	
Sealing / Water Resistance	IEC 60529 class IP54; Dust Protected, Splash Proof, (battery pack installed)	

* From room temperature to temperature extreme, one hour duration.

Environmental Specifications (continued)

Category	Specification
ESD and EMI (radiated immunity)	Refer to Section 8.1.7 for details
Radio Frequency Emissions Applicable Directive and Standards	R&TTE Directive 1999/5/EC ETSI EN 300 220-2 V2.1.2 (2007-06) ERC RECOMMENDATION 70-03 ETSI EN 301 489-3 V1.4.1 (2002-08)

8.1.3 Defibrillator

Category	Specification
Waveform	Impedance Compensated Biphasic Truncated Exponential
Energy	Adult: 150 Joules (nominal [±15%] delivered into a 50 ohm load) Child / Infant: 50 Joules (nominal [±15%] delivered into a 50 ohm load)
Charge control	Automatic by Patient Analysis System
Charge time	4 seconds or less (from shock advised)* Charge time may increase at the end of battery life and for temperatures below 10°C.
Charge time from the initiation of rhythm analysis to readiness for discharge	Meets or exceeds AAMI DF80 and IEC 60601-2-4 requirements
Charge time measured from initially switching power on to charge ready	Meets or exceeds AAMI DF80 and IEC 60601-2-4 requirements
Charge complete indication	<ul style="list-style-type: none"> • SHOCK required indicator flashing • Unit announces imminent shock delivery ("Shocking in 3, 2, 1...")
Shock delivery	Fully automatic
DISARM	<ul style="list-style-type: none"> • If Patient Analysis System decides rhythm is no longer shockable • If defibrillation pads are removed from patient or unplugged from unit • If operator presses the ON/OFF button for approximately two seconds, device will disarm and turn off

* Typical, new battery, at 25°C.

8.1.4 Waveform Specifications

The DDU-120 AED delivers a 150J Biphasic Truncated Exponential waveform to patients with impedances ranging from 25 to 180 ohms.

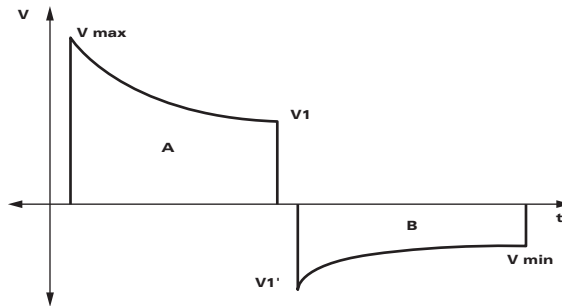

The waveform is adjusted to compensate for measured patient impedance. Nominal phase times and energy delivered are shown in the tables that follow.

Adult

Patient Impedance	Phase A Duration	Phase B Duration	Energy Delivered
25 Ω	2.8 ms	2.8 ms	153 J
50 Ω	4.1 ms	4.1 ms	151 J
75 Ω	7.2 ms	4.8 ms	152 J
100 Ω	9.0 ms	6.0 ms	151 J
125 Ω	12.0 ms	8.0 ms	153 J
150 Ω	12.0 ms	8.0 ms	146 J
175 Ω	12.0 ms	8.0 ms	142 J

Pediatric

Patient Impedance	Phase A Duration	Phase B Duration	Energy Delivered
25 Ω	4.1 ms	4.1 ms	35 J
50 Ω	5.8 ms	3.8 ms	47 J
75 Ω	5.8 ms	3.8 ms	51 J
100 Ω	7.2 ms	4.8 ms	53 J
125 Ω	7.2 ms	4.8 ms	52 J
150 Ω	9.0 ms	6.0 ms	53 J
175 Ω	9.0 ms	6.0 ms	51 J



8.1.5 Patient Analysis System

The Patient Analysis System ensures that the pad/patient impedance is within the proper range and analyzes the patient's ECG rhythm to determine whether a shock is required. On detection of a non-shockable rhythm, the user is prompted to perform CPR. For shockable rhythms, the AED automatically charges in preparation for shock delivery.

The patient analysis system will detect electrical "noise" or artifact in the ECG signal that may interfere with accurate rhythm analysis. This artifact may be caused by excessive motion to the patient or by external electrical noise. When this artifact is present, the AED will prompt the user to "stop motion" or "stop interference" until the ECG signal is free of noise and then proceed to analysis.

8.1.5.1 Shockable Rhythm Criteria

When placed on a patient meeting the indications for use criteria, the DDU-120 AED is designed to recommend a defibrillation shock when it detects proper pad impedance and one of the following:

Ventricular Fibrillation	Peak-to-peak amplitude at least 200 μ Volts.  Warning: Some very low amplitude or low frequency VF rhythms may not be interpreted as shockable.
Ventricular Tachycardia (including ventricular flutter and polymorphic VT)	Cardiac rhythm rate of at least 180 bpm and peak-to-peak amplitude at least 200 μ Volts.  Warning: Some very low amplitude or low frequency VT rhythms may not be interpreted as shockable.

The DDU-120 AED is designed to recommend *no* shock for all other rhythms, including Normal Sinus Rhythms, fine Ventricular Fibrillation (<200 μ Volts), and some slow Ventricular Tachycardias and Asystole.

8.1.5.2 Patient Analysis System Performance

Rhythm Class	ECG Test Sample ¹ Size	Algorithm Performance ¹		Specifications
		Performance ²	90% Lower Confidence Limit ²	
Shockable Rhythm – Ventricular Fibrillation	227	>97%	>95%	Meets or exceeds IEC-60601-2-4 requirements; meets the AAMI DF80 requirement and the AHA recommendation ² of Sensitivity > 90%
Shockable Rhythm – Ventricular Tachycardia	101	99%	>97%	Meets or exceeds IEC-60601-2-4 requirements; meets the AAMI DF80 requirement and the AHA recommendation ² of Sensitivity > 75%
Non-Shockable Rhythm – Normal Sinus Rhythm	213	100%	100%	Meets or exceeds IEC-60601-2-4 requirements; meets the AAMI DF80 requirement of Specificity > 95% and the AHA recommendation ² of Specificity > 99%
Non-Shockable Rhythm – Asystole	113	100%	100%	Meets or exceeds IEC-60601-2-4 requirements; meets the AAMI DF80 requirement and the AHA recommendation ² of Specificity > 95%
Non-Shockable Rhythm – All other non-shockable rhythms	248	>99%	>98%	Meets or exceeds IEC-60601-2-4 requirements; meets the AAMI DF80 requirement and the AHA recommendation ² of Specificity > 95%

1. From Defibtech ECG Rhythm Databases.
2. *Automatic External Defibrillators for Public Access Defibrillation: Recommendations for Specifying and Reporting Arrhythmia Analysis Algorithm Performance, Incorporating New Waveforms, and Enhancing Safety.* American Heart Association (AHA) Task Force on Automatic External Defibrillation, Subcommittee on AED Safety and Efficacy. *Circulation*, 1997;95:1677-1682.

8.1.6 Clinical Summary

The DDU-120 AED uses a Biphasic Truncated Exponential waveform with specifications that are substantially equivalent to the waveform specifications of the device used in the study* cited below. The DDU-120 AED has not been the subject of a published clinical study.

8.1.6.1 Background

The objective of this study was to compare AEDs that delivered 150-J biphasic shocks with AEDs that delivered high-energy (200- to 360-J) monophasic shocks.

* Schneider T, Martens PR, Paschen H, et al. Multicenter, randomized, controlled trial of 150J biphasic shocks compared with 200- to 360-J monophasic shocks in the resuscitation of out-of-hospital cardiac arrest victims. *Circulation* 2000;102:1780-1787.

8.1.6.2 Methods

AEDs were prospectively randomized according to defibrillation waveform on a daily basis in four emergency medical services systems. First responders used either the 150-J biphasic AEDs or 200- to 360-J monophasic waveform AEDs on victims where defibrillation was indicated. A sequence of up to three defibrillation shocks was delivered: 150J-150J-150J for the biphasic units and 200J-200J-360J for the monophasic units. Defibrillation was defined as termination of VF for > 5 seconds, without regard to hemodynamic factors.

8.1.6.3 Results

Of 338 patients with an out-of-hospital cardiac arrest, 115 had a cardiac etiology, presented with ventricular fibrillation, and were shocked with one of the randomized AEDs. There were no statistical differences between the monophasic and biphasic groups in terms of age, sex, weight, primary structural heart diseases, cause or location of arrest, bystanders who witnessed the arrest, or type of responder. A summary of the results is presented in table below.

	Biphasic Patients Number (%)	Monophasic Patients Number (%)	P Value
Defibrillation Efficacy:			
1 shock	52/54 (96%)	36/61 (59%)	< 0.0001
< 2 shocks	52/54 (96%)	39/61 (64%)	< 0.0001
< 3 shocks	53/54 (98%)	42/61 (69%)	< 0.0001
Patients defibrillated	54/54 (100%)	49/58 (84%)	0.003
ROSC	41/54 (76%)	33/61 (54%)	0.01
Survival to Hospital Admission	33/54 (61%)	31/61 (51%)	0.27
Survival to Hospital Discharge	15/54 (28%)	19/61 (31%)	0.69

8.1.6.4 Conclusion

More patients were defibrillated with an initial biphasic shock than monophasic shock and ultimately the biphasic waveform defibrillated at higher rates than the monophasic waveform. A higher percentage of patients achieved Return Of Spontaneous Circulation ("ROSC") after biphasic shocks. Rates of survival to hospital admission and discharge did not statistically differ between the two waveforms.

8.1.7 Electromagnetic Conformity

Guidance And Manufacturer's Declaration

The essential performance of the DDU-120 AED is successful delivery of defibrillation therapy and accurate differentiation between shockable and nonshockable rhythms.

DDU-120 AEDs are intended for use within the electromagnetic environment specified below. The customer or the user of the DDU-120 AED should assure that it is used within the stated environmental specifications.



Electromagnetic Emissions

Emissions test	Compliance	Electromagnetic environment – guidance
RF emissions CISPR 11 CISPR 22 FCC Part 15	Group 1 Class B Class B Class B	The DDU-120 AED uses RF energy only for its internal function. Therefore, its RF emissions are very low and are not likely to cause any interference in nearby electronic equipment.
Harmonic emissions IEC 61000-3-2	Not applicable	Battery operated equipment
Voltage fluctuations/flicker emissions IEC 61000-3-3	Not applicable	Battery operated equipment

Electromagnetic Immunity

Immunity test	IEC 60601 test level	Compliance level	Electromagnetic environment – guidance
Electrostatic discharge (ESD) IEC 61000-4-2	±8 kV contact ±15 kV air	±8 kV contact ±15 kV air	There are no special requirements with respect to electrostatic discharge.
Electrical fast transient/burst IEC 61000-4-4	±2 kV for power line supply lines ±1 kV for input/output lines	Not applicable	Battery operated equipment
Surge IEC 61000-4-5	±1 kV line(s) to line(s) ±2 kV line(s) to earth	Not applicable	Battery operated equipment
Voltage dips, short interruptions and voltage variations on power supply input lines IEC 61000-4-11	Not applicable	Not applicable	Battery operated equipment
Power frequency (50/60 Hz) magnetic field IEC 61000-4-8	3 A/m	3 A/m	Power frequency magnetic fields should not be greater than levels characteristic of a typical location in a commercial or hospital environment.

Electromagnetic Immunity (continued)

Immunity test	IEC 60601 test level	Compliance level	Electromagnetic environment – guidance		
Radiated RF IEC 61000-4-3	20 V/m 80 MHz to 2.5 GHz 80% 5Hz AM Modulation	20 V/m	<p data-bbox="929 224 1223 464"> Portable and mobile RF communications equipment should be used no closer to any part of the DDU-120 AED, including cables, than necessary. The recommended separation distance calculated from the equation applicable to the frequency of the transmitter is shown in the following table. </p> <table border="1" data-bbox="929 477 1223 630"> <tr> <td data-bbox="929 477 1072 630">  </td> <td data-bbox="1072 477 1223 630"> <p data-bbox="1082 488 1213 623"> Interference may occur in the vicinity of equipment marked with this symbol. </p> </td> </tr> </table>		<p data-bbox="1082 488 1213 623"> Interference may occur in the vicinity of equipment marked with this symbol. </p>
	<p data-bbox="1082 488 1213 623"> Interference may occur in the vicinity of equipment marked with this symbol. </p>				
<p data-bbox="201 639 815 660">Note 1: At 80 MHz and 800 MHz, the higher frequency range applies.</p> <p data-bbox="201 670 1210 716">Note 2: These guidelines may not apply in all situations. Electromagnetic propagation is affected by absorption and reflection from structures, objects and people.</p>					
<p data-bbox="201 735 1172 781">The ISM (industrial, scientific and medical) bands between 150 kHz and 80 MHz are 6,765 MHz to 6,795 MHz; 13,553 MHz to 13,567; 26,957 MHz to 27,283 MHz; and 40,66 MHz to 40,70 MHz.</p> <p data-bbox="201 790 1223 954">Field strengths from fixed transmitters, such as base stations for radio (cellular/cordless) telephones and land mobile radios, amateur radio, AM and FM radio broadcast and TV broadcast cannot be predicted theoretically with accuracy. To assess the electromagnetic environment due to fixed RF transmitters, an electromagnetic site survey should be considered. If the measured field strength in the location in which the DDU-120 AED is used exceeds the applicable RF compliance level above, the DDU-120 AED should be observed to verify normal operation. If abnormal performance is observed additional measures may be necessary, such as reorienting or relocating the DDU-120 AED.</p>					

Separation Distances

DDU-120 AEDs are intended for use in an electromagnetic environment in which radiated RF disturbances are controlled. The customer or the user of a DDU-120 AED can help prevent electromagnetic interference by maintaining a minimum distance between portable and mobile RF communications equipment (transmitters) and the DDU-120 AED as recommended below, according to the maximum output of the communications equipment.

Recommended separation distances between portable and mobile RF communications equipment and DDU-120 AEDs		
Rated maximum output power of transmitter	Separation distance according to frequency of transmitter	
	80 MHz to 800 MHz	800 MHz to 2.5 GHz
	$d = 1.2\sqrt{P}$	$d = 2.3\sqrt{P}$
0.01 W	0.12 m	0.23 m
0.1 W	0.38 m	0.73 m
1 W	1.20 m	2.30 m
10 W	3.79 m	7.27 m
100 W	12.00 m	23.00 m

For transmitters rated at a maximum output power not listed above, the recommended separation distance (d) in meters (m) can be determined using the equation applicable to the frequency of the transmitter, where P is the maximum output power rating of the transmitter in watts (W) according to the transmitter manufacturer.

Note 1: As 80 MHz and 800 MHz, the separation distance for the higher frequency range applies.

Note 2: The ISM (industrial, scientific and medical) bands between 150 kHz and 80 MHz are 6,765 MHz to 6,795 MHz; 13,553 MHz to 13,567 MHz; 26,957 MHz to 27,283 MHz; and 40,66 MHz to 40,70 MHz.

Note 3: An additional factor of 10/3 is used in calculating the recommended separation distance for transmitters in the ISM frequency bands between 150 kHz and 80 MHz and in the frequency range 80 MHz to 2.5 GHz to decrease the likelihood that mobile/portable communications equipment could cause interference if it is inadvertently brought into patient areas.

Note 4: These guidelines may not apply in all situations. Electromagnetic propagation is affected by absorption and reflection from structures, objects and people.

Regulatory Compliance

Changes or modifications of this product, not expressly approved by Defibtech, may void the user's authority to operate the equipment.

This device complies with part 15 of the FCC Rules and Industry Canada Radio Standard RSS-210. Operation is subject to the following two conditions:

- (1) This device may not cause harmful interference, and
- (2) This device must accept any interference received, including interference that may cause undesired operation.

This equipment has been tested and found to comply with the limits for a Class B digital device, pursuant to part 15 of the FCC Rules. These limits are designed to provide reasonable protection against harmful interference in a residential installation. This equipment generates, uses and can radiate radio frequency energy and, if not installed and used in accordance with the instructions, may cause harmful interference to radio communications. However, there is no guarantee that interference will not occur in a particular installation. If this equipment does cause harmful interference to radio or television reception, which can be determined by turning the equipment off and on, the user is encouraged to try to correct the interference by one or more of the following measures:

- Reorient or relocate the receiving antenna.
- Increase the separation between the equipment and receiver.
- Connect the equipment into an outlet on a circuit different from that to which the receiver is connected.
- Consult the dealer or an experienced radio/TV technician for help.

CE Marking and European Union Compliance – Radio Transmitter

Defibtech, L.L.C. declares that the DDU-120 AED radio transmitter is in compliance with the essential requirements and other relevant provisions of Directive 1999/5/EC. Applicable standards are listed in the "Environmental" section in Section 8.1.2 of this manual.

8.2 Battery Packs



IMPORTANT NOTE: DDU-120 AEDs that carry the marking shown at left on the pad holder label on the unit's rear panel (see Section 5.2.7 for diagram) should use DBP-1400 and DBP-2800 battery packs that also include this marking.

Earlier model battery packs without this marking will function during a rescue, but should not be used for standby. If an earlier model battery pack is installed, the AED will prompt the user on shut down that an unknown battery type is present. The battery pack should be replaced with one that includes the marking shown above.

8.2.1 High-Capacity Lithium Battery Pack

Category	Specification
Model number	DBP-2800
Main battery type	15VDC, 2800 mAh, Lithium/Manganese Dioxide. Disposable, recyclable, non-rechargeable.
Capacity	300 shocks or 16 hours of continuous operation.*
Charge time	4 seconds or less (from shock advised).*
Active Status Indicator (ASI) battery	9VDC, 1200 mAh, Lithium/Manganese Dioxide. Disposable, recyclable, non-rechargeable.
Battery pack standby-life	7 years (installed in AED with 9V ASI battery).*

*Typical, new battery, at 25°C

8.2.2 Standard Lithium Battery Pack

Category	Specification
Model number	DBP-1400
Main battery type	15VDC, 1400 mAh, Lithium/Manganese Dioxide. Disposable, recyclable, non-rechargeable.
Capacity	125 shocks or 8 hours of continuous operation.*
Charge Time	4 seconds or less (from shock advised).*
Active Status Indicator (ASI) battery	9VDC, 1200 mAh, Lithium/Manganese Dioxide. Disposable, recyclable, non-rechargeable.
Battery pack standby-life	5 years (installed in AED with 9V ASI battery).*

*Typical, new battery, at 25°C

8.3 Defibrillation Pads

Defibtech defibrillation pads have the following characteristics:

Category	Specification	
Model number	DDP-100	DDP-200P
Type	Adult	Child < 8 years; < 55 lbs. (25 kg)
Intended use	Disposable	Disposable
Adhesion	Self-adhesive	Self-adhesive
Active gel surface area	16 inches ² (103 cm ²) each (nominal)	7.75 inches ² (50 cm ²) each (nominal)
Cable/connector type	Integrated	Integrated
Cable length	4 feet (122 cm) (typical)	4 feet (122 cm) (typical)
Expiration date	2.5 years from date of manufacture	2.5 years from date of manufacture

Note: In the event of a suspected pad defect, the pads should be clearly marked “Not for Use” and returned to Defibtech for analysis. (Refer to the “Contacts” section of this manual for contact information regarding returns.)

8.4 Defibtech Data Cards (DDCs)

Use only Defibtech Data Cards in the DDU-120 AED. Defibtech Data Cards are available as follows:

Standard DDC:

Model Number	Details
DDC-12	Up to 12 hours of ECG data

Audio-enabled DDC:

Model Number	Details
DDC-100AE	Up to 1 hour and 40 minutes of audio and ECG data













Note: The DDU-120 AED will attempt to log at least an hour of ECG data if possible. In an audio-enabled DDC, audio logging will be turned off if needed to preferentially record ECG information. If a partially filled DDC is used, it is possible that only ECG (i.e. no Audio) will be logged. Every time the unit is turned on, a file is created on the DDC – the DDC card can hold a maximum 255 files. Once a card is completely filled with data or files all DDC logging will stop, but selected internal ECG logging will continue.

8.5 DefibView













DefibView is a PC-based application program that runs on Windows platforms. It allows review of ECG data and other patient and device performance parameters after an emergency event.

To download DefibView software and see system requirements specifications, go to www.defibtech.com/support and click on "Software Utilities."







9 Glossary of Symbols

Symbol	Meaning
	High voltage present.
	Caution, consult accompanying documents.
	SHOCK Required Indicator – Flashes to indicate that a shock is about to be delivered.
	ON/OFF/DISARM Button – - Turns the device ON when it is OFF. - Turns the device OFF when it is ON. - DISARMS the device when it is charged and then turns the device OFF.
	Do not expose to high heat or open flame. Do not incinerate.
	Recyclable.
	Consult operating instructions.
	Refer to instruction manual / booklet.
	Do not damage or crush.
	Follow proper disposal procedures.
	Meets the requirements of the European Medical Device Directive.
	Meets the requirements of the Radio Equipment and Telecommunications Directive, 1999/5/EC.

Glossary of Symbols (continued)

Symbol	Meaning
	Operational temperature limitation.
	Use by yyyy-mm-dd.
	Defibrillation proof - Can withstand the effects of an externally applied defibrillation shock. Internally powered with defibrillator-proof BF-type patient applied parts (per EN 60601-1).
	Manufacturer.
	Date of manufacture.
	Manufacturer and date of manufacture.
	Do not reuse.
	For USA users only.
Rx ONLY	Federal Law (USA) restricts this device to sale by or on the order of a physician.
	Catalogue number.
	Keep dry.
	Handle with care.
	Transportation and storage requirements. See environmental requirements on packaging.

Glossary of Symbols (continued)

Symbol	Meaning
	Authorized European Representative: Emergo Europe Molenstraat 15 2513 BH The Hague The Netherlands
	Does not contain latex.
	Lot number.
IP54	Dust protected; Protected against water jets.
	Classified by TUV Rheinland of NA with respect to electric shock, fire, and mechanical hazard only in accordance with UL 60601-1, CAN/CSA C22.2 No.601.1-M90, IEC 60601-1, and IEC 60601-2-4. Conforms to UL Standard UL 60601-1. Certified to CAN/CSA Standard C22.2 No. 601.1-M90.
	Serial number.
	Lithium manganese dioxide battery.
	Product is not sterile.

10 Contacts



Defibtech, L.L.C.
741 Boston Post Road, Suite 201
Guilford, CT 06437 USA

Tel.: 1-(866) 333-4241 (Toll-free within North America)
1-(203) 453-4507
Fax : 1-(203) 453-6657

Email:
sales@defibtech.com (Sales)
reporting@defibtech.com (Medical Device Reporting)
service@defibtech.com (Service and Repair)



11 Warranty Information

ORIGINAL END USER'S LIMITED WARRANTY*

COVERAGE

Defibtech, LLC provides a limited warranty that the defibrillator and its associated accessories (e.g., batteries and pads), whether purchased concurrently with the defibrillator as part of a configuration or separately, shall be substantially free from defects in material and workmanship. Defibtech's limited warranty shall only extend to the original end user, where the original end user purchased the items from an authorized Defibtech, LLC retailer. This limited warranty may not be assigned or transferred. The terms of the Limited Warranty in effect as of the date of original purchase shall apply to any warranty claims.

LENGTH OF WARRANTY

The defibrillator's limited warranty is for a period of eight (8) years from the date of purchase. The battery's limited warranty is for a period of four (4) years from the date of purchase, but in no event shall the limited warranty period extend past the date printed on the battery. Single use accessories (e.g., the pads) shall have a limited warranty up to use or for a period up to the expiration date, whichever is earlier. The limited warranty for all other accessories is for a period of one (1) year from the date of purchase, or to the expiration date, whichever is earlier.

LIMITED WARRANTY LIMITATIONS

This limited warranty does not cover damage of any sort resulting from, but not limited to, accidents, improper storage, improper operation, alterations, unauthorized service, tampering, abuse, neglect, fire, flood, war, or acts of God. Additionally, this limited warranty does not cover damage of any sort to the defibrillator or its associated accessories resulting from the use of the defibrillator with unapproved accessories or use of the accessories with unapproved medical devices. The defibrillator and its associated accessories are not warranted to be compatible with any other medical device.

LIMITED WARRANTY VOIDED

The limited warranty is immediately voided if: the defibrillator or its associated accessories are serviced or repaired by any entity, including persons, not authorized by Defibtech, LLC; specified maintenance is not performed; the defibrillator is used with one, or more, unauthorized accessories; the associated accessories are used with an unauthorized defibrillator; or the defibrillator or associated accessories are not used in accordance with Defibtech, LLC approved instructions.

EXCLUSIVE REMEDY

At Defibtech, LLC's sole discretion, Defibtech shall have the option to repair, replace, or provide a credit. In the event of replacement, Defibtech shall have the right at its sole discretion to replace the item with a new, or refurbished, same or similar item. Determination of a similar item shall be at the sole discretion of Defibtech. In the case of replacement,

the replacement at a minimum shall reflect the prorated time remaining for the item based on the remaining limited warranty period. In the case of a credit, the credit shall be the prorated value of the item based on the lower of the original item cost of the same or similar item and the remaining limited warranty period. In no event, shall the limited warranty period of a replacement item extend past the limited warranty period of the item it is replacing.

WARRANTY SERVICE

In order to obtain warranty service, contact the retailer from whom the item was purchased, or Defibtech, LLC customer service. In the event an item must be returned, a Return Material Authorization (RMA) number is required. Items returned without an RMA number will not be accepted. The item shall be shipped at the original end user's expense to a destination specified by the retailer or Defibtech, LLC.

OBLIGATIONS AND WARRANTY LIMITS

THE FOREGOING LIMITED WARRANTY IS IN LIEU OF AND SPECIFICALLY EXCLUDES AND REPLACES, TO THE DEGREE PERMITTED BY APPLICABLE STATE LAW, ALL OTHER EXPRESS OR IMPLIED WARRANTIES, INCLUDING, BUT NOT LIMITED TO, THE IMPLIED WARRANTIES OF MERCHANTABILITY AND FITNESS FOR A PARTICULAR PURPOSE.

NO PERSON (INCLUDING ANY AGENT, DEALER, OR REPRESENTATIVE OF DEFIBTECH, LLC) IS AUTHORIZED TO MAKE ANY REPRESENTATION OR WARRANTY CONCERNING THE DEFIBRILLATOR OR ITS ASSOCIATED ACCESSORIES, EXCEPT TO REFER TO THIS LIMITED WARRANTY.

THE EXCLUSIVE REMEDY WITH RESPECT TO ANY AND ALL LOSSES OR DAMAGES RESULTING FROM ANY CAUSE WHATSOEVER SHALL BE AS SPECIFIED ABOVE. DEFIBTECH, LLC SHALL IN NO EVENT BE LIABLE FOR ANY CONSEQUENTIAL OR INCIDENTAL DAMAGES OF ANY KIND, INCLUDING, BUT NOT LIMITED TO, EXEMPLARY DAMAGES, SPECIAL, PUNITIVE, COMMERCIAL LOSS FROM ANY CAUSE, BUSINESS INTERRUPTION OF ANY NATURE, LOSS OF PROFITS OR PERSONAL INJURY, EVEN IF DEFIBTECH, LLC HAS BEEN ADVISED OF THE POSSIBILITIES OF SUCH DAMAGES, HOWEVER OCCASIONED, WHETHER BY NEGLIGENCE OR OTHERWISE, UNLESS APPLICABLE STATE LAW DOES NOT ALLOW SUCH EXCLUSION OR LIMITATION.

**Applicable to defibrillators and associated accessories having a date of manufacture on or after January 1, 2013. For all others, refer to warranty information in effect at the time of manufacture.*

This product and its accessories are manufactured and sold under license to at least one or more of the following United States patents: 5,591,213; 5,593,427; 5,601,612; 5,607,454; 5,611,815; 5,617,853; 5,620,470; 5,662,690; 5,735,879; 5,749,904; 5,749,905; 5,776,166; 5,800,460; 5,803,927; 5,836,978; 5,836,993; 5,879,374; 6,016,059; 6,047,212; 6,075,369; 6,438,415; 6,441,582.

For additional patent information, please see:
www.defibtech.com/support/patents