

The Trainer's Guide:

Defibtech Lifeline ARM®

Automated Chest Compression System



RAC-A1515EN-BB rev B

ELECTRONIC DISTRIBUTION



Disclaimer

This document is a training guide that provides basic information about the Defibtech Lifeline ARM device (also known as Defibtech model number RMU-1000), which is a mechanical cardiopulmonary resuscitation (CPR) device. In this Trainer's Guide, the Lifeline ARM device is presented in example situations, which may not represent some or all of actual in-use situations. Also, the order of events is suggested and may vary based on the any number of factors, such as the number of rescuers present. As a result, this Trainer's Guide should not be considered comprehensive as covering all operational Lifeline ARM device scenarios. This Trainer's Guide is properly considered as a supplement to the RMU-1000 User Manual, which can be viewed or downloaded at www.defibtech.com. In the case of any perceived conflict between this Trainer's Guide and the RMU-1000 User Manual, the RMU-1000 User Manual shall be considered the definitive source document as to the operation and maintenance requirements of the Lifeline ARM device. A thorough understanding of the RMU-1000 User Manual is required to operate the Lifeline ARM device safely and effectively in normal operations, such as emergency situations.

Notices

Defibtech, LLC, shall not be liable for errors contained herein or for incidental or consequential damages in connection with the furnishing, performance, or use of this material.

Information in this document is subject to change without notice. Names and data used in the examples are fictitious unless otherwise noted.

Warning and Cautions

For a complete list of warnings and cautions pertaining to the Lifeline ARM device, refer to the RMU-1000 User Manual which can be viewed or downloaded at www.defibtech.com.

Copyright

Copyright © 2022 Defibtech, LLC

All rights reserved. Copyright questions should be directed to Defibtech. For contact information, refer to Chapter 5 of this guide.

Contents

- 1 Before Training Starts 4**
 - Getting Ready 4
 - Know Your Group 5
 - Know Your Setup 5
 - Prepare Devices, Accessories, and Training Materials. 5
 - Operator Training Requirements 6

- 2 Group Training Sessions 7**
 - Course Content. 7
 - Introducing the Lifeline ARM Device. 8*
 - Getting Familiar with the Lifeline ARM Device 10*
 - Learning the Deployment Sequence. 20*
 - Transporting the Patient 28*
 - Disassembling and Storing the Lifeline ARM Device 28*
 - Recommended Maintenance for the Lifeline ARM Device. 29*
 - Indicators That May Illuminate During Operation of the Lifeline ARM Device. . . 30*
 - Troubleshooting During Operation of the Lifeline ARM Device 31*

- 3 Hands-On Training and Practice 32**
 - Setting Up the Practice Groups. 32
 - Evaluating the Students 32
 - Course Content. 33

- 4 Resources 36**

- 5 Contacts 40**

1 Before Training Starts

As a trainer, you will be teaching other medical personnel how to use the Lifeline ARM device effectively in a real-life rescue situation. This helpful guide has all the information and practical pointers you'll need to prepare students to:

- Deploy the Lifeline ARM device to administer automated chest compressions with minimal interruption to manual CPR
- Adjust the Lifeline ARM device to provide effective compressions at a consistent rate and depth
- Maintain and store the Lifeline ARM device so it will be ready for future use

The course is conducted in two parts:

1. A group session in which the trainer will go over the written information in this guide
2. Practice groups to provide high-quality, hands-on training and evaluation

A crucial part of the learning process, the hands-on training and practice sessions allow students to watch and learn from their peers, receive instant feedback on how well they are performing, and hone their skills before putting them to use in a real-life rescue.

After these training sessions, your students should also be able to pass on the knowledge and expertise they learn from you.

As the leader of the training, be sure to refer to the User Manual for complete directions, indications, contraindications, side effects, training requirements, dangers, warnings, cautions, troubleshooting, maintenance, and technical specifications.

Remember it is the responsibility of all students/operators to read the User Manual before operating the Lifeline ARM device.

Getting Ready

In addition to the basics of how to operate and maintain the Lifeline ARM device, this guide includes information on how to successfully conduct your training sessions.

Each training section begins with specific information **For the Trainer**, which you should review before each session. At the start of each Course Content section, you'll see a checklist of **Key Concepts** that summarizes the material your students should master. Refer to this checklist to stay focused on the essential elements during the actual training. You'll also see **Trainer Tips** — helpful hints and notes related to that particular section of the training.

Your training sessions will go much more smoothly when you are well prepared. Knowing who you will be teaching, where and how the sessions will be held, and having all materials ready to go are key to effective training.

Know Your Group

Each group will be different and you will be training providers who work in different environments, both in and out of the hospital. Try to establish before each session what type of professionals will be in your group so you can tailor your training to their needs.

Know Your Setup

Well in advance of your training session, make sure your designated facility offers the appropriate resources. You will need:

- A room large enough for the entire group and with enough open floor space for the group to break into the hands-on practice sessions (or enough alternate rooms to accommodate all practice groups)
- Enough seating and desktop space for students to be able to write notes and take tests
- Adequate power and outlets for video / PowerPoint presentations (if used) and to charge the Battery Pack of the Lifeline ARM device if needed

Prepare Devices, Accessories, and Training Materials

Print and refer to this checklist before each session to be sure you have all materials fully prepared and ready for use.

For each group of 6 students, you will need:

1. A prepared Lifeline ARM device and all relevant accessories:

- Backboard, Frame, Carrying Case, Compression Module, Battery Pack, Patient Interface Pad (PIP), Stabilization Strap, Wrist Straps, AC Adapter, Quick Reference Guide, and User Manual.



2. A fully-charged Battery Pack

- Remember to charge Battery Packs at least 2-3 hours before each session.



3. An anatomically representative full-body manikin, sized appropriately for an adult, that is designed for manual CPR training, works best. Torso manikins with flat backs or too many functions or electronics might be problematic, as well as manikins without arms do not adequately demonstrate the interaction between the Frame and the Stabilization Strap.

4. Competency Checklists, Student Self-Tests, Training Evaluations, and Certificates of Completion.
(pages 36,37,38 and 39)

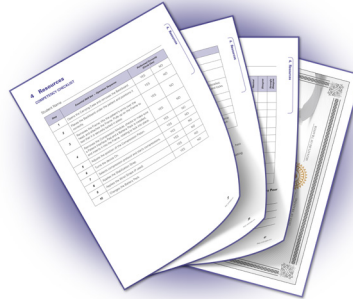

Operator Training Requirements

The Lifeline ARM device is intended for use by qualified medical personnel certified to administer CPR (e.g. first responders, ambulatory personnel, nurses, physicians or medical staff). To safely and effectively operate the Lifeline ARM device, it is the responsibility of the operator to obtain the following training:

- Lifeline ARM device training in accordance with the User Manual, including handling of the actual device
- CPR training in accordance with recent resuscitation guidelines as required by local, state, provincial, and/or national regulations, (e.g., the American Heart Association or the European Resuscitation Council).
- Thorough knowledge and understanding of the material in the User Manual

Note: *This course is not intended to provide CPR certification.*

2 Group Training Sessions

FOR THE TRAINER

At the beginning of each group session, welcome your students and introduce yourself and the other training staff. If the size of the group allows, ask your students to introduce themselves and the type of environment in which they work. This information can help you anticipate specific questions that may come up during the training as well as create a feeling of common purpose for the students.

Trainer Tip: If the group session is too large for each student to speak, ask the other trainers to lead off with introductions in the practice sessions.

Setting the Agenda

Let your students know what to expect during the session by providing an agenda and establishing a timeline for breaks.

A typical training session lasts about 1 to 1-1/2 hours and includes:

Welcome and introduction

- Group Session:
 - Overview and review of the Quick Reference Card
 - Demonstration of the components and assembly of the Lifeline ARM device
 - Demonstration of the operation sequence of the Lifeline ARM device
 - Discussion of device use and removal, patient transport, and maintenance
- Break
- Hands-on Training Sessions:
 - Small practice groups for team practice in rotation and student self-tests
 - Evaluations by trainers of student competency
- Time for questions and completion of Training Evaluations

Course Content

KEY CONCEPTS

At the end of this session, your students should know:

- ✓ Benefits of automated chest compressions during CPR (page 8)
- ✓ When — and when NOT — to use the Lifeline ARM device (page 9)
- ✓ Side effects of CPR (page 9)
- ✓ Components of the Lifeline ARM device and how they function (page 10)

- ✓ Operation sequence for the Lifeline ARM device (page 20)
- ✓ How to transport a patient while using the Lifeline ARM device (page 28)
- ✓ How to disassemble the Lifeline ARM device (page 28)
- ✓ How to clean and store the Lifeline ARM device (page 29)

Introducing the Lifeline ARM Device



As emergency responders know, any lifesaving technique demands a high level of excellence in its delivery. During CPR, it is crucial that rescuers provide effective and uninterrupted chest compressions to maximize the patient's chest compression fraction. Maintaining a level of consistency during manual CPR can be difficult — and sometimes impossible if there are not enough rescuers or if the patient requires transport.

The Lifeline ARM device offers an automated solution for providing victims of sudden cardiac arrest with high-quality CPR. It is intended for use as an adjunct to manual CPR when effective manual CPR is not possible (e.g., during patient transport, or extended CPR when fatigue may prohibit the delivery of effective/consistent compressions to the victim, or when insufficient personnel are available to provide effective CPR).

The device is easy to use, easy to transport, and delivers continuous compressions at the depth and rate recommended by the guidelines of the American Heart Association (AHA) and the European Resuscitation Council (ERC).

The following statement comes from the *Highlights of 2015 American Heart Association Guidelines Update for CPR and ECC*¹:

- There is continued emphasis on the characteristics of high-quality CPR: compressing the chest at an adequate rate and depth, allowing complete chest recoil after each compression, minimizing interruptions in compressions, and avoiding excessive ventilation.
- The recommended chest compression rate is at least 100 per minute.
- The recommendation for chest compression depth for adults is at least 2 inches (5 cm).

Indications for Use

Before and during use of the Lifeline ARM device, you should always follow the accepted guidelines and your local protocol for CPR.

Once you have confirmed that the patient is unconscious and not breathing, begin manual CPR and get ready to deploy the Lifeline ARM device as appropriate.

1. American Heart Association. *Highlights of 2015 American Heart Association Guidelines Update for CPR and ECC*. Dallas, TX: American Heart Association; 2015; p5.

Use of the Lifeline ARM device is appropriate when effective manual CPR is not possible, such as:

- During extended CPR when rescuer fatigue may compromise consistent and effective compressions
- During patient transport
- When there are not enough rescuers present to deliver adequate and effective CPR

The Lifeline ARM device is intended for use as an adjunct to manual cardiopulmonary resuscitation (CPR) when effective manual CPR is not possible (e.g., during patient transport, or extended CPR when fatigue may prohibit the delivery of effective/consistent compressions to the victim, or when insufficient personnel are available to provide effective CPR).

Federal Law (USA) restricts this device to sale by or on the order of a physician.

Contraindications

Be prepared to recognize situations in which use of the Lifeline ARM device is not appropriate.

Do not use the Lifeline ARM device in the following cases:

- It is not possible to position the Lifeline ARM device safely or correctly on the patient's chest
- The patient is too small for the starting piston height to reach the patient's chest
- The patient is too large for the Frame to attach to the Backboard or if the Compression Module/Piston cannot be mounted without compressing the patient's chest

Always follow local and/or recognized resuscitation guidelines for CPR when using the Lifeline ARM device.

Side Effects

All operators of the Lifeline ARM device should be aware of potential side effects of CPR, which were well established by 2005. The International Liaison Committee on Resuscitation (ILCOR) states the following side effects of CPR:

"Rib fractures and other injuries are common but acceptable consequences of CPR given the alternative of death from cardiac arrest. After resuscitation, all patients should be reassessed and re-evaluated for resuscitation-related injuries." *(From the 2005 International Consensus Conference on Cardiopulmonary Resuscitation and Emergency Cardiovascular Care Science With Treatment Recommendations, hosted by the American Heart Association in Dallas, Texas, January 23–30, 2005. Published in Circulation. 2005; 112: III-5-III-16.)*

The above side effects, as well as bruising and soreness of the chest, may commonly occur after the use of the Lifeline ARM device. *(Black CJ, Busuttill A, Robertson C. Chest wall injuries following cardiopulmonary resuscitation. Resuscitation. 2004 Dec;63(3):339-43.)*

Getting Familiar with the Lifeline ARM Device

The Lifeline ARM device is designed to be stored in a Carrying Case with a small number of easy-to-assemble components; it can also be stored in a fully assembled and ready-to-use state. When you receive a Lifeline ARM device, identify each component and ensure that the package is complete before use.

The key components of the Lifeline ARM device include:

- The Backboard
- The Frame
- The Compression Module
 - Compression Piston with Patient Interface Pad (PIP)
 - User Control Panel
 - Battery Pack
- AC Adapter
- A Stabilization Strap
- Patient Wrist Straps
- The User Manual and Quick Reference Guide

Trainer Tip: As you begin this section, place a Lifeline ARM device in its closed Carrying Case on a table or raised surface so the group can see what you are doing. As you open the Carrying Case and remove its contents, demonstrate and discuss the function and details of each component in sequence.

Remind students that they will have lots of opportunity to familiarize themselves with the physical components during the hands-on training session.



The Backboard



The lightweight Backboard is the base for the Lifeline ARM device. It is placed under the patient and has attachment points on either side to which the Frame latches. The Backboard should be positioned as shown on the positioning diagram, with the center in line with the patient's nipple line.

The Frame



The single-piece Frame attaches to the Backboard and holds the Compression Module in position over the patient. With the Backboard attached, the Frame is designed to create a rigid structure that enables a consistent compression depth without unwanted flex or distortion during operation. The latches are self-centering and self-locking and are easy to match up with, and snap into, the Backboard.

There are two sets of wide-release levers located on each side of the frame. These levers allow the user to detach both sides of the Frame together or one side at a time. It offers easy access to the patient.

The Frame is large enough to accommodate a broad range of patient sizes (weight is not a factor).

The Compression Module



The removable Compression Module contains all the active components of the Lifeline ARM device system, including the User Control Panel, Battery Pack, and Compression Piston. It also houses a software-controlled motor that controls both the rate and depth of compressions.

The User Control Panel is located at the top, the Battery Pack slides into the side, and the Compression Piston (with the Patient Interface Pad) is located at the bottom, facing the patient.

To attach the Compression Module to the Frame, insert the locking sleeve at about 90 degrees into the module receptacle at the top of the Frame. Rotate the Module in either direction until it is in line with the Frame and snaps to lock securely into place.

To remove the Compression Module from the Frame, push down on the Module and rotate about 90 degrees in either direction. Lift the Module out of the Frame.

To attach a Patient Interface Pad, press the pad onto the end of the Piston until it snaps into place, rotating the pad if necessary. To remove the Patient Interface Pad, grasp the pad by the edges and gently pull down one edge. Each Patient Interface Pad is for one-time use only; it is non-sterile and contains no latex.

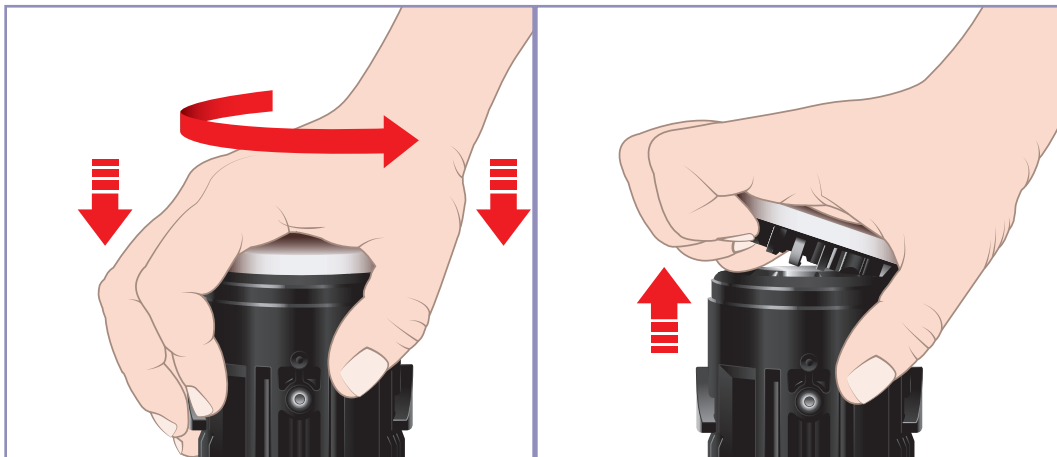

The User Control Panel

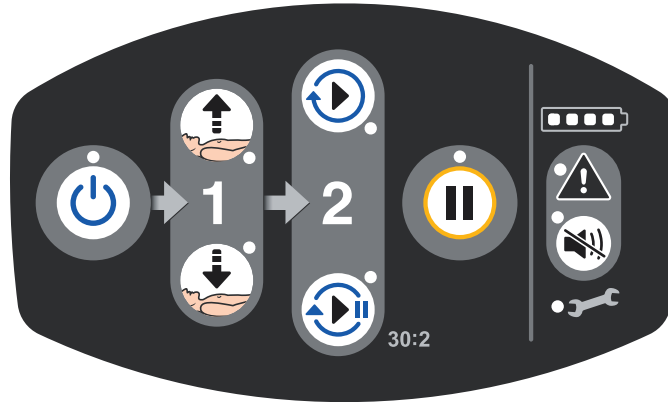

Trainer Tip: Point out each of the buttons on the User Control Panel as you discuss them.

The User Control Panel is intuitive and easy to use. After being powered on, it requires just two steps to initiate mechanical CPR:

1. Press the Up/Down buttons to adjust the height of the Compression Piston relative to the patient's chest



2. Press one of two buttons to select a rescue protocol:
 - Chest compressions only
 - Chest compressions with rescue breaths



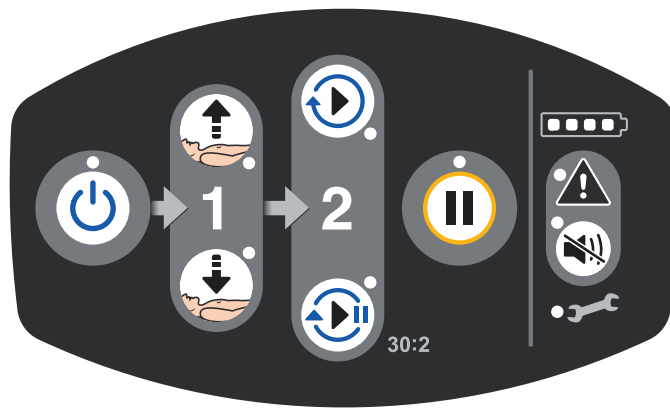

During a rescue, you can toggle between these two protocols, and compressions can be stopped (paused) or resumed.





Here is an overview of the functions on the User Control Panel:

 **ON/OFF Button** — Press for at least one second to turn the Lifeline ARM device on or off

 **Up/Down Buttons** — Use to position the Piston relative to the patient’s chest. LED indicators adjacent to the Adjust Up/Down Buttons illuminate and blink when the Lifeline ARM is requesting that the piston be adjusted to the patient’s chest.

 **Run Compressions** — To perform continuous compressions, press the top button. The adjacent LED will flash at the rate the AHA/ERC/ILCOR suggests for giving rescue breaths without the Lifeline ARM device stopping for delivery of breaths (approximately 1 breath every 6 seconds).

 To perform compressions with pauses for rescue breaths, press the bottom button. A reminder chirp and flashing LED will occur during the 3 compressions prior to the ventilation pause.

 **Pause Button** — Stops compressions when running or resumes compressions when stopped

 **Battery Pack Indicator** — Indicates the approximate remaining Battery Pack capacity

 **Warning Indicator** — Illuminates to notify the user that there is a problem with the compression module and immediate attention is needed

 **Warning Mute Button** — Silences the audible sound associated with a warning for one minute

 **Service Indicator** — Will illuminate to indicate when the Lifeline ARM device requires servicing

The Battery Pack



The Lifeline ARM device is powered by a replaceable Battery Pack that slides into the Compression Module. The Battery Pack must always be installed in the unit to operate the device, even when powered by the AC Adapter.

The Compression Module should be turned off, or paused if in use, whenever batteries are swapped out. To remove the Battery Pack, squeeze the eject release latches on either side of the Battery Pack opening.

To insert the Battery Pack, be sure the contacts are facing the device and push in until the latch clicks. When the device is turned on, the Battery Pack Status indicator will display the Battery Pack's power status throughout its use.

When fully-charged, the Battery Pack will provide about 60 minutes of compressions. With the Battery in the Compression Module at room temperature and in the off state, the external AC Adapter can charge the battery in less than 3 hours.



A new battery is set to ship mode. Must be activated before use! Activate battery by charging in unit or charger. See User Manual for details.

To charge the Battery Pack with the AC Adapter:

1. Insert the Battery Pack into the Compression Module.
2. Connect the AC Adapter plug to the external power input jack on the Compression Module. Lock it in place by aligning the raised notch on the plug with the notch on the jack. While the Battery Pack is charging, a green LED on the Compression Module's Battery Pack Indicator will flash slowly.

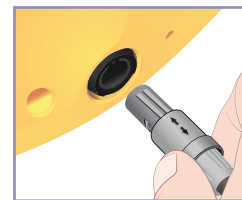

To check the Battery Pack's charge with LED status indicator on the Battery Pack:

Press and hold the check charge button on the Battery Pack. A full charge is indicated by all LEDs in the Battery Pack Indicator above the check charge button lighting up.



To replace the Battery Pack during operation:

If the Battery Pack charge becomes very low during use, the warning and Battery Pack indicators will flash and the Battery Pack status indicator will show only one red indicator LED.



When Battery Pack indicator shows one red segment, replace Battery Pack as soon as possible or apply external power.

If this happens, there are two options:

Option 1: Swap with a sufficiently charged spare Battery Pack.

- Push Pause on the User Control Panel to temporarily stop compressions.
- Press the Battery Pack Release to quickly eject the depleted Battery Pack and remove it.
- Insert the charged spare Battery Pack.
- Wait for the Pause LED indicator to illuminate.
- Restart compressions by pushing the Pause button again or one of the Run buttons.

Note: If the Battery Pack change takes more than approximately 15 seconds, the unit will power off with the piston in place. Upon spare Battery Pack insertion, the Compression Module must be powered on and the piston will automatically retract to set its start position. The piston should then be re-adjusted to patient's chest.



The Lifeline ARM device must be paused in order to replace a Battery Pack. Failure to do so will require the user to power up the Lifeline ARM device and reset the start position in order to resume compressions.

Option 2: Connect the Lifeline ARM device to an external power source by connecting the AC Adapter to the external input jack of the Compression Module. The Battery Pack must always be installed in the Compression Module to operate the device, even when powered by the AC Adapter.



Only use Defibtech accessories to power the Lifeline ARM device from an external power source.

Trainer Tip: Demonstrate how to remove and replace the Battery Pack, and review the Battery Pack Indications and Alerts on the User Control Panel. Also point out the location of the external input jack on the Compression Module.

The Stabilization Strap, Patient Wrist Straps

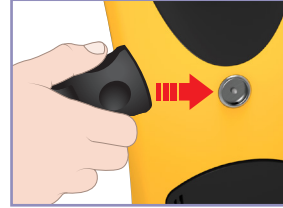
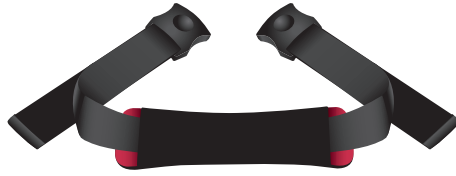

The Stabilization Strap holds the Lifeline ARM device securely in the correct position in relation to the patient. It snaps into the Stabilization Strap connectors located on the Frame.

Trainer Tip: Point out the location of the Stabilization Strap connectors on the Frame.

The Patient Wrist Straps

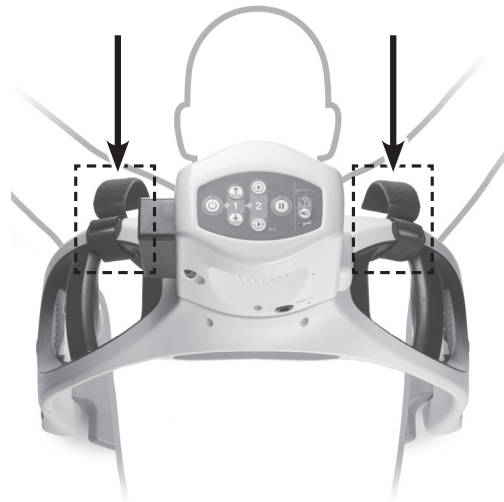
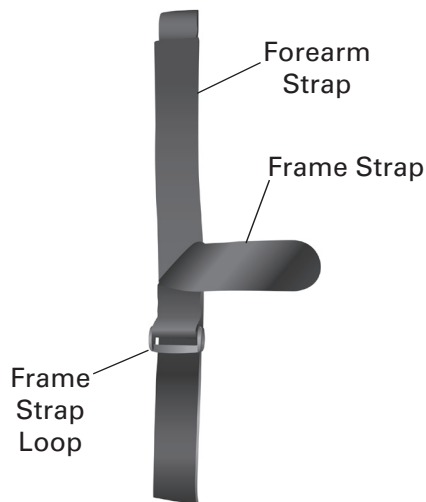

The Patient Wrist Straps attach a patient's arms to the Lifeline ARM device for ease of transporting the patient and the unit together. As shown in the above left illustration, each Patient Wrist Strap is comprised of two main strap sections: a Frame Strap that attaches to the Frame and a Forearm Strap that wraps around the patient's wrist.

To maximize the available time to perform a rescue, the Patient Wrist Straps should be affixed to the Frame **prior** to a rescue and the Frame should be stored in the Carrying Case with the Patient Wrist Straps already attached.

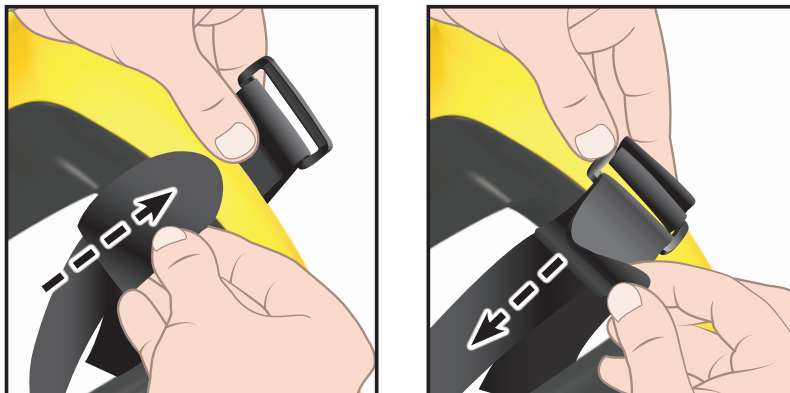

- Attach the Frame Strap to the Frame by inserting the rounded end of the Frame Strap through the Frame Strap Loop, as shown in the above left illustration.
- After the Frame Strap has been inserted through the Frame Strap Loop, pull the end of the Frame Strap in the opposite direction so that the Frame Strap is tightly wrapped around the Frame, as shown in the above right illustration. Secure using the Velcro® on the underside of the Frame Strap.
- If necessary, rotate the attached Patient Wrist Strap so that the Forearm Strap component faces up.
- Repeat the above steps to attach the second Patient Frame Strap's Frame Strap to the Frame.

Trainer Tip: Inform trainees that, when attaching the Frame to the Backboard, the Patient Wrist Straps should be oriented towards the patient's head to maintain access to the Frame's Backboard Release Levers.

Other Components and Accessories

Other Lifeline ARM device components include the Patient Interface Pad, AC Adapter, Wrist Straps, User Manual, and Quick Reference Guide. Available options include: a USB cable, spare Battery Pack, Patient Interface Pads (package of 3), a Battery Pack Charging Station, and a Tactical Carrying Case.



Only use approved accessories with the Lifeline ARM device. The Battery Pack, Battery Charger, and AC Adapter are specifically designed for use with the device. Using other accessories can cause permanent damage and void the warranty.

Reviewing Initial Assembly

To quickly assemble the Lifeline ARM device, follow this sequence:

1. Attach the Frame to the Backboard.



Trainer Tip: Emphasize the importance of making sure that the Patient Wrist Straps have been installed on the Frame prior to rescue usage of the device as this will save time when the patient needs to be transported.

2. Insert the Compression Module into the receptacle of the Frame. Rotate the Module until it is in line with the Frame and snaps into place.



3. Check that the Patient Interface Pad (PIP) is installed. If not, attach it to the end of the Piston by pressing the pad onto the Piston until it snaps into place, rotating pad if necessary.

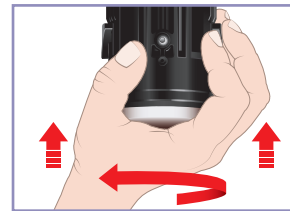

Trainer Tip: Emphasize the importance of making sure a Patient Interface Pad (PIP) is installed on the Compression Module.

4. Insert a fully charged Battery Pack into the opening in the side of the Compression Module.

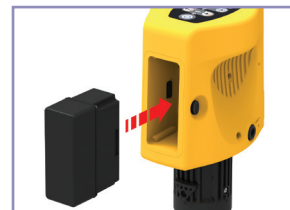

Trainer Tip: Remind trainees that the Battery Pack must always be installed in the unit in order to operate the Lifeline ARM device, even when powered by the AC adapter.

Before using the Lifeline ARM device, always check to be sure it is completely assembled and that all components are present and functional. Check the Battery Pack to be sure it is fully charged.

The following section, “*Learning the Deployment Sequence*,” provides a more detailed view of the assembled components and how they are used during a rescue.

Trainer Tip: Before moving on to the next section, ask if anyone has questions or concerns.

Learning the Deployment Sequence

To minimize CPR interruptions and to most effectively use the Lifeline ARM device it is recommended two rescuers work as a team.

Before and during deployment of the Lifeline ARM device:

- Confirm that the patient is unresponsive and not breathing.
- Start manual compressions.
- Minimize compression interruptions as much as possible.
- Perform manual compressions whenever possible.

Team dynamics are important. Establish who will be in charge of starting manual CPR and who will perform the various steps of assembly.

Trainer Tip: Remind students that providing manual compressions always takes precedence over the setup and use of the device.

This section of the course covers the core elements of how to deploy the Lifeline ARM device in a real-time emergency setting. The goal of the rescuer is to put the Lifeline ARM device into action as quickly and smoothly as possible.

Trainer Tip: Working with the Lifeline ARM device around a manikin and a partner while talking at the same time can be a challenge: Practice this aspect of the training beforehand to be sure participants can hear you and see what you are doing.

Steps to Deploy the Lifeline ARM Device:

The following instructions are for a two-rescuer scenario that begins after it has been confirmed that the patient is unresponsive and not breathing, clothing has been removed from the patients chest and manual CPR has begun.

Trainer Tip: If a set of trainees encounters any problems during setup of the Lifeline ARM device, consider having all trainees temporarily cease setup to explain to the group what issue was encountered and what the appropriate corrective actions are to fix the problem.

1. Open the Carrying Case and remove the Backboard.

Place the Backboard next to the patient.



2. Place the Backboard under the patient.

Lift and roll the patient as needed to slide the Backboard underneath the patient's armpits and in line with the nipple line according to the positioning diagram. Accurately placing the Backboard now will make it easier to correctly align the Compression Module later on. Resume manual CPR.

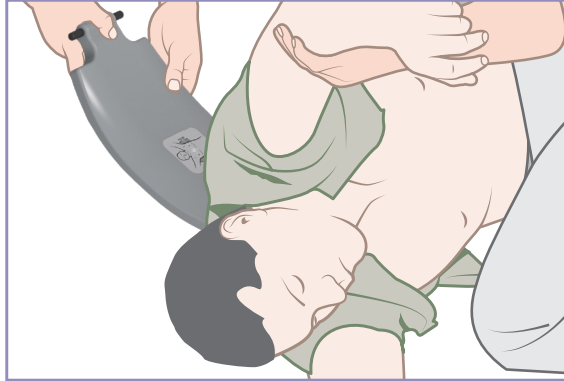

3. Attach the Frame to the Backboard.

While continuing manual CPR, position the Frame over the patient.

Attach the Frame to the Backboard by aligning the Frame latches over the Backboard pins and pushing down until the latches snap into place. The latches may be clicked into place one at a time or simultaneously.

Pull up on the Frame to make sure it is securely attached to the Backboard.



4. Attach the Compression Module to the Frame.

Continue manual CPR.

Check the Compression Module to be sure the Patient Interface Pad and Battery Pack are installed.

Insert the Module into the Frame and rotate in either direction until the Module is in line with the Frame and snaps to lock into place.



5. Adjust the placement of the Compression Piston relative to the patient's chest.

Adjust the Frame and Backboard to position the Compression Piston over the patient's chest and directly in line with the nipples. (This is the same target point used for manual CPR.)

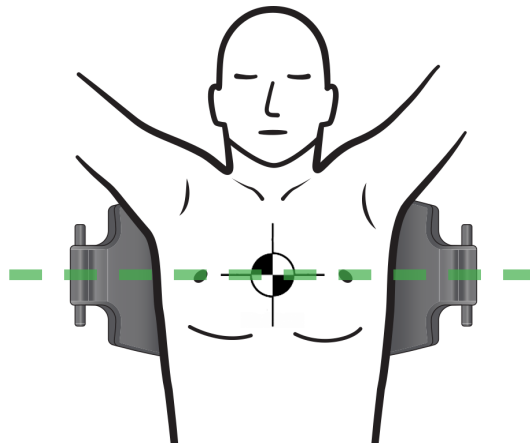

6. Turn the unit On.



Press the ON/OFF button on the Control Panel for at least one second. If the Battery Pack indicator shows red for low battery or the device does not turn on, replace the Battery Pack or connect the AC Adapter.

7. Adjust the height of the Compression Piston relative to the patient's chest.

Interrupt manual CPR to adjust the height of the Compression Piston. Press the "Adjust Down" and "Adjust Up" buttons on the Control Panel as needed while guiding the Piston with the other hand until it is firmly touching the patient's chest.

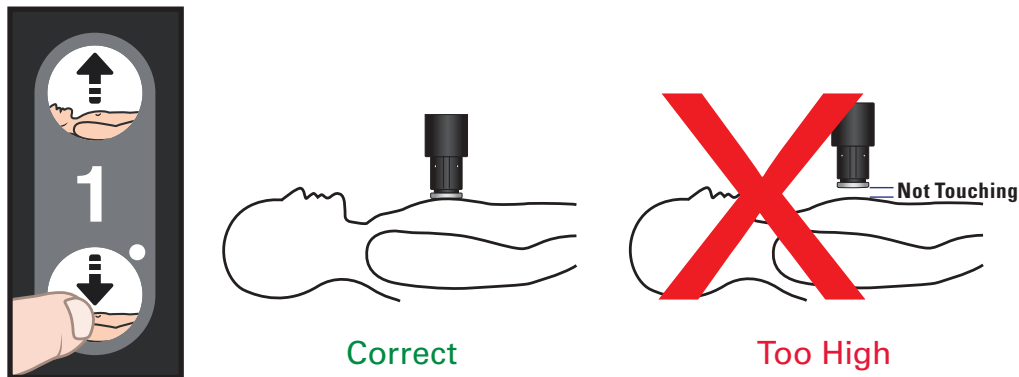

8. Start chest compressions.

Once the Piston is properly adjusted, push the "Run Continuous" button OR the "Run with Breaths" button in accordance with your emergency response protocol.

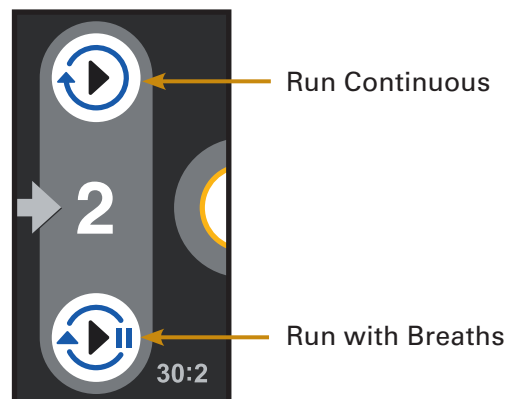

To temporarily stop compressions for any reason, press the pause button. If necessary, make adjustments to the Piston position using the Adjust Up/Down Buttons so that it is making firm contact with the patient's chest. To resume compressions, push the "Run Continuous" button OR the "Run with Breaths" button.

Compressions may also stop or fail to start because the Piston requires adjustment to the patient's chest. The Lifeline ARM device will indicate that Piston adjustment is required by blinking the Adjust Up/Down LEDs. Press the Pause button to clear a Piston adjustment error condition. Readjust the Piston using the Adjust Up/Down Buttons so that it is making firm contact with the patient's chest. To resume compressions, push the "Run Continuous" button OR the "Run with Breaths" button.

The Lifeline ARM device can withstand the effects of an externally applied defibrillation shock.

9. Apply the Stabilization Strap.

Remove the Stabilization Strap from the Carrying Case.

Lift the patient's head and slide the Stabilization Strap under the patient's neck. If the patient might have head, neck, spine, or other bone-structure injuries, use accepted handling techniques.

Attach the Stabilization Strap to the Frame on both sides by pushing the strap clips into the connectors until they click into place.

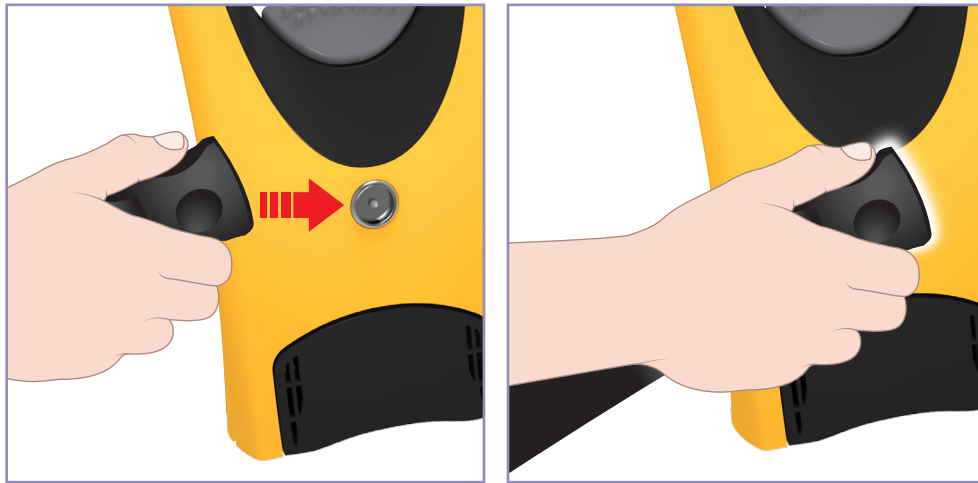

Tighten the Stabilization Strap to maintain the Piston's correct position over the patient's chest by adjusting the Velcro® that holds both clips to the Stabilization Strap.

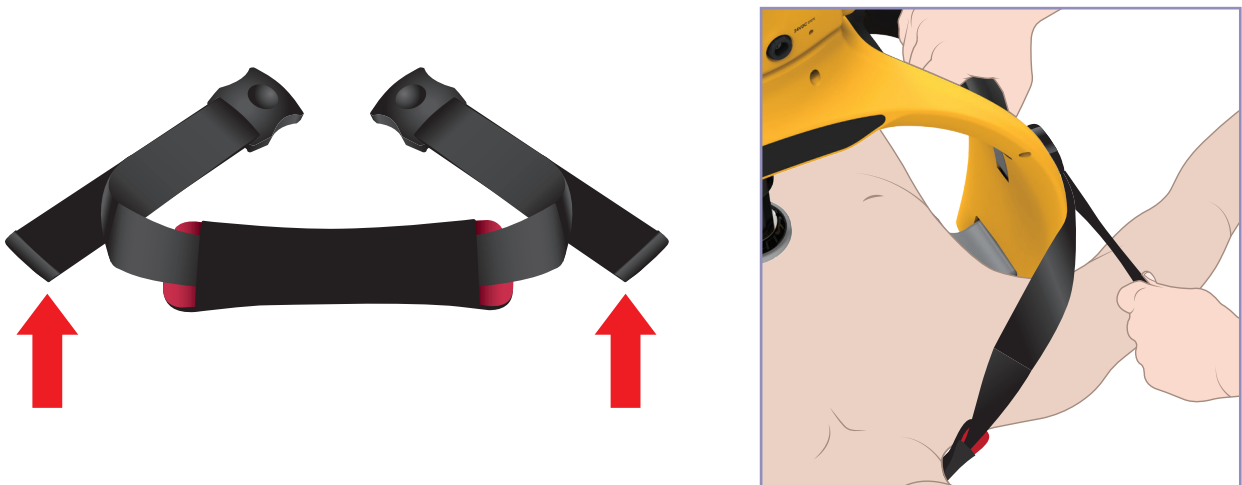

10. Securing the Patient Wrist Straps to the Patient

Secure the Forearm Strap of the Patient Wrist Strap by placing the patient's wrist on top of the Forearm Strap and placing the soft Velcro part of the strap across the patient's wrist, as shown in the above left illustration.

Secure the patient's wrist to the Frame by wrapping the hooked Velcro onto the soft Velcro section, as shown in the above right illustration. Make sure that the strap securely holds the patient's arm in place.

Repeat the above two steps to secure patient's other arm to the Frame.

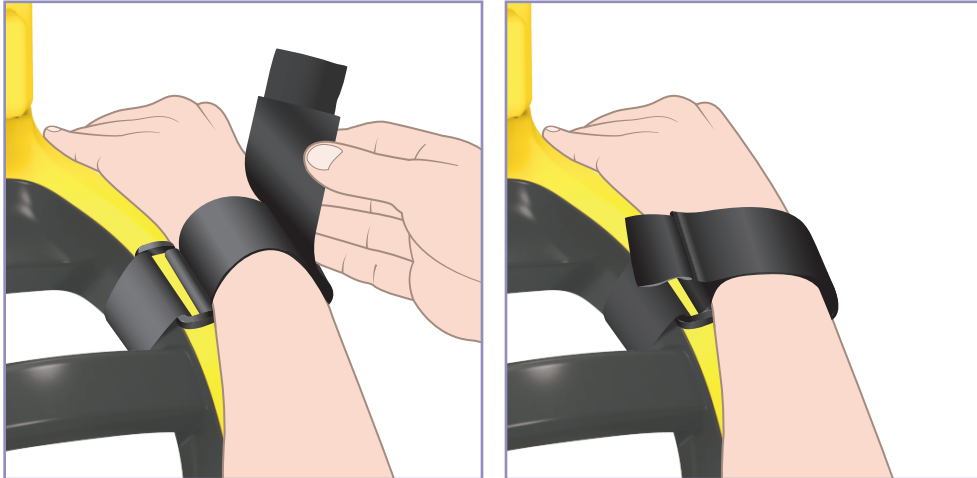

SELECTED IMPORTANT WARNINGS WHEN USING THE LIFELINE ARM

- Patient size is the determining factor when deploying the Lifeline ARM; there is no limitation regarding patient weight.
- If the Piston cannot be adjusted to reach the patient's chest, the patient is too small. Remove the Frame and continue manual CPR.
- If the Frame cannot be latched, the patient is too big. Remove the Frame and continue manual CPR.
- If at any time compressions cannot be performed by the Lifeline ARM, resume manual CPR.
- If there is a malfunction during emergency use and the Lifeline ARM device cannot be paused or powered off, remove the Battery Pack from the Compression Module. When the device has stopped, remove the Frame from the patient (as the Piston does not automatically retract when the Battery Pack is removed). Start manual compressions as soon as possible.
- If a spare Battery Pack or external power source are not available and the Lifeline ARM device stops compressions, remove the unit from the patient and begin manual compressions immediately.

During use:

- Always pause the device before changing the Battery Pack.
- Always pause compressions before performing ECG analysis with other equipment.
- The Battery Pack must always be installed in the Compression Module to operate the device, even when powered by the AC Adapter.
- Avoid getting gel on the patient's chest (e.g., from defibrillation pads) in the area of the Piston target area.

During storage:

- Always store the device so it is ready for use.
- Always have the external AC Adapter available with the device at all times.
- Store the Compression Module with a fully charged Battery Pack installed.
- Store the Compression Module with a new Patient Interface Pad installed.
- Store the Frame with clean Patient Wrist Straps securely attached.
- Be sure the Stabilization Strap and extra Patient Interface Pads are available.
- Consider keeping a spare fully charged Battery Pack on hand.

Note: Refer to the User Manual for complete directions, indications, contraindications, side effects, training requirements, warnings, cautions, troubleshooting, maintenance and technical specifications.

Transporting the Patient

To move the patient to a stretcher or other transport equipment:

1. Prepare the stretcher/transport equipment near the patient.
2. Position two people, one on either side of the patient; other personnel may be needed to stabilize the patient's head and limbs, as necessary.
3. When ready to move the patient, push the "Pause" button to temporarily stop compressions.
4. Lift the patient by grabbing the black handle of the Frame with one hand using the other hand to support the lower torso.
5. After the patient is safely positioned on the stretcher/transport equipment, check that the positions of the unit and the Piston have not changed; readjust if necessary; compressions may then be continued.
6. Push the "Pause" button or the appropriate "Run Compressions" button to resume compressions.

Disassembling and Storing the Lifeline ARM device

When compressions are no longer needed, follow this sequence to remove the device:

1. Turn the unit off by pressing and holding the ON/OFF button for at least one second.
2. To release a patient's arm from the Patient Wrist Strap, pull up on the fabric tab on the end of the Forearm Strap until the Velcro is no longer holding the patient's arm in place. Repeat for the patient's other arm.
3. Remove the Stabilization Strap.
4. Remove the Compression Module from the Frame by first pushing down and rotating it about 90 degrees in either direction. Lift out the Module and place it in the appropriate storage section of the Carrying Case.
5. Release the Frame from the Backboard using the release levers.
Note: *The Frame can be released one side at a time. Lift the Frame and place it in its storage section of the Carrying Case.*
6. Pack the Backboard in the Carrying Case on top of the fabric flap that covers and protects the Compression Module.
7. Add remaining components and accessories, including the Stabilization Strap, Wrist Straps, AC Adapter, spare Battery Pack, extra PIPs, User Manual, and Quick Reference Guide.

Recommended Maintenance for the Lifeline ARM Device

To be sure that all components and accessories are available and ready for next use:

- 1.** Make sure the Battery Pack is fully charged and inserted into the Compression Module.
- 2.** Check the condition of the system. Make sure the Carrying Case contains all components and accessories, including the Patient Interface Pad(s), AC Adapter, Stabilization Strap, Patient Wrist Straps, User Manual, and Quick Reference Guide.
- 3.** Make sure the Patient Interface Pad is installed on the Compression Module.
- 4.** Make sure at least one unused Patient Interface Pad is stored in the Carrying Case.
- 5.** Check the Battery Pack expiration date.
- 6.** Turn the device on to perform a self-test. Make sure the Compression Piston is retracted and the PAUSE indicator comes on with no warning indicators.

Clean all components before the next use as recommended in the User Manual.

Different maintenance intervals may be appropriate depending on the environment. Ultimately, the maintenance program is at the discretion of the medical director.

Indicators That May Illuminate During Operation of the Lifeline ARM Device

Battery Pack Indicator



- If the Battery Pack indicator on the User Control Panel shows red (low battery), replace the Battery Pack as soon as possible with a sufficiently charged Battery Pack or apply external power.
- At any time, the Lifeline ARM device can be connected to an external power source to power the device during its operation, or to charge the battery. *NOTE: The Battery Pack must always be installed in the Compression Module to operate the Lifeline ARM device, even when it is being powered by the AC Adapter.*

Warning Indicators

The Warning Indicators on the User Control Panel will illuminate and be accompanied by an audible alert to notify the user of a detected problem, such as possible misuse or malfunction. Pressing the Warning Mute button causes the LED to illuminate red and silences the alert for one minute.

If the Warning Indicator (located below the Battery Pack Indicator on the User Control Panel) illuminates and is accompanied by an audible alert:



- Check for an installed and charged Battery Pack
- Check for proper Piston position and height

If the Adjust Up/Down LEDs are both blinking, the Piston position requires adjustment to the patient's chest. Press the Pause button and readjust the Piston using the Adjust Up/Down Buttons so that it is making firm contact with the patient's chest. To resume compressions, push the appropriate run compressions button.

To clear the condition and try again, press the Pause button. If the device fails to perform compressions, push the ON/OFF button for at least one second to power off. Then push the ON/OFF button again for at least one second to turn it back on.

Service Indicator

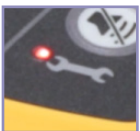

Defibtech recommends periodic maintenance every 18 months of use. The Service Indicator is the wrench symbol located on the User Control Panel. After approximately 200 hours of operation, the Service Indicator LED will flash to indicate that the unit requires maintenance. The device may still be used but should be serviced as soon as practical.

Trainer Tip: Remind students that if they encounter device issues, they should always minimize compression interruptions and perform manual compressions whenever possible.

Troubleshooting During Operation of the Lifeline ARM Device

Some examples from the complete table that appears in the User Manual for the Lifeline ARM device detailing symptoms/observations, possible causes of and solutions to common problems include:

<i>Symptom/Observation</i>	<i>Possible Cause</i>	<i>Corrective Action</i>
Lifeline ARM device will not turn on	On/Off button pressed but not held down for at least one second	Press and hold the On/Off button for a full one second. All Control Panel LEDs will briefly illuminate and a beep will be heard when the Lifeline ARM device is powered on.
	Battery Pack is not installed	Install charged Battery Pack.
	Battery Pack depleted	Charge depleted Battery Pack or replace depleted Battery Pack with a charged Battery Pack.
	Battery Pack malfunction	Replace Battery Pack with a charged Battery Pack.
	Lifeline ARM device malfunction	Remove Lifeline ARM device from patient and start manual chest compressions as soon as possible.
Lifeline ARM device immediately turns off	Battery Pack is depleted	Charge depleted Battery Pack or replace depleted Battery Pack with a charged Battery Pack.
	Battery Pack malfunction	Replace Battery Pack.
	Lifeline ARM device malfunction	Remove Lifeline ARM device from patient and start manual chest compressions as soon as possible.
Adjust Up/Down LED indicators blinking	Piston position adjustment required	Adjust the Piston until it is firmly touching the patient's chest. Retry compressions.
Lifeline ARM device fails to start compressions	Piston position adjustment required or Lifeline ARM device malfunction	If condition persists, push the On/Off Button for at least one second to power off the Lifeline ARM device. Retry Operation and Adjustment. If condition persists after troubleshooting, remove Lifeline ARM device from patient and start manual chest compressions as soon as possible.
Lifeline ARM device stops during compressions		
Compressions are not sufficient, or something unusual occurs during operation		

IMPORTANT: The above troubleshooting table represents select entries from the full table that appears in the User Manual. Refer to the User Manual for complete instructions on how to handle potential problems encountered before, during, or after use of the Lifeline ARM device.

Trainer Tip: If any problems defined in the troubleshooting chart in the User Manual occur while trainees are using the Lifeline ARM device, have all trainees pause their Lifeline ARM device and explain to the entire training group what problem was encountered and what the appropriate corrective action is for that particular problem.

3 Hands-On Training and Practice

FOR THE TRAINER

The practice session is the student's opportunity to put theory into practice. This is where trainers can ensure that students understand and demonstrate competency in handling and using the Lifeline ARM device in a rescue scenario.

Setting Up the Practice Groups

After the break, divide the classroom group into smaller practice groups. The student to trainer ratio should be no more than six to one in each of the smaller groups. Ask each group to divide themselves into teams of two. One student will provide manual CPR while the other practices the operation sequence; they then switch roles.

Ask students to use the Student Self-Test during the Hands-On Session, both for review of the operation sequence and as a reference while they watch other teams practice.

Depending upon how many Lifeline ARM devices are available for practice, manage the teams as they rotate through the session to be sure that each student goes through the operation sequence at least three times.

In each practice group, trainers should follow the same protocol:

1. Trainers and students introduce themselves.
2. Trainer reviews and demonstrates deployment of the Lifeline ARM device at the expected speed and proficiency.
3. Students take turns working in teams of two to practice deployment. As each team works, the other teams and the trainer watch, referring to the Student Self-Test, and provide feedback. Teams rotate practice sessions until all students have completed at least three deployments.
4. Students have the opportunity to review and ask questions of the trainers.
5. Trainers complete a Competency Checklist evaluation for each student.
6. Trainer selects one student to "be the trainer." This student acts as the trainer for the group to demonstrate the ability to teach others to use the Lifeline ARM.

Evaluating the Students

Learning happens best without fear or pressure. Remind students that you are there to help them learn, not to criticize them or "catch" them making errors. Ask whether anyone has concerns or questions that you can address before the evaluations. If needed, explain and demonstrate any areas that are unclear.

Once students show that they are comfortable and confident in using the Lifeline ARM, they are ready to be evaluated per the Competency Checklist (page 36). For each hands-on evaluation, watch the student perform the operation sequence beginning with opening the Carrying Case of the Lifeline ARM device. Check that each step is done correctly according to the checklist, and note any feedback that may help the student later on.

Trainer Tip: Carrying a clipboard makes it easy to move around to observe the student while completing the Competency Checklist.

At the end of the hands-on evaluation, share your results with the student and go over any areas that were not correctly performed or could be improved.

Course Content

KEY CONCEPTS

At the end of the Hands-On Session, students should be able to demonstrate their ability to correctly and efficiently:

- ✓ Position the Backboard
- ✓ Attach the Frame
- ✓ Insert the Compression Module
- ✓ Operate and understand all functions of the User Control Panel: ON/OFF, Up/Down, Continuous Compressions or With Breaths
- ✓ Start and stop manual CPR during deployment
- ✓ Correctly attach the Stabilization Strap and Wrist Straps
- ✓ Change the Battery Pack or apply the AC Adapter during operation

Step-by-Step Review of Lifeline ARM Operation Sequence: Key Takeaways

Following the steps on the Student Self-Test (page 37), students watch as the trainer reviews the essential elements of the operation sequence and then demonstrates deployment at full speed as needed during an emergency. Based on performance testing, the expected deployment time (from the time the Backboard is used to the first compression) is less than 45 seconds.

With a manikin ready, begin the review with a Lifeline ARM device in the Carrying Case nearby and another participant acting as the second rescuer. As you demonstrate each step, emphasize the elements that are most important.

1. Open the Carrying Case and remove the Backboard.

Instruct partner: "Stop manual CPR."

Key Takeaways:

- Show how to open the Carrying Case

2. Place the Backboard under the patient and position it correctly.

Instruct partner: “Restart manual CPR.”

Key Takeaways:

- Show that the Backboard is placed next to the patient with the positioning label facing up.
- Show how to roll the manikin to slide the Backboard into the proper position, just below the armpits with the center of the Backboard in line with the nipple line of the patient.

3. Remove the Frame from the Carrying Case; check for clearance. Attach the Frame to the Backboard. Pull up on the Frame to test that it is securely locked in place.

Key Takeaways:

- Point out that the Frame can be attached to both latches at once or one side at a time.
- Demonstrate the correct position of the patient’s arms using the manikin.
- Show how much to pull up on the Frame for an effective test.
- Remind students that if the patient is too large for the Frame, they should remove the Frame and continue manual CPR.

4. Remove the Compression Module from the Carrying Case and insert it into the Frame, rotating until it is in line with the Frame and snaps to lock into place. Check that the Patient Interface Pad is in place.

Key Takeaways:

- Show how to orient the Compression Module at the top of the Frame so that it sits crosswise. Insert the Module and show how to rotate it by 90 degrees to lock it in place.
- Remind students that the Module can be oriented in either direction for faster assembly.
- Show how to check the Patient Interface Pad. Remove it and replace it, and remind students that it is for one-time use only.

5. Turn the device On.

Key Takeaways:

- Remind students to press the ON/OFF button for at least one second. If the Battery Pack indicator shows red (low battery) or the device does not turn on, they should replace the Battery Pack or connect the AC adapter.
- If the AC Adapter gets connected, remind students that the Battery Pack must always be installed in the Compression Module to operate the Lifeline ARM.

6. Adjust the height and position of the Compression Piston.

Key Takeaways:

- Show how to use the Up/Down buttons on the User Control Panel to adjust the height of the Piston until it is touching the patient’s chest.
- Remind students to confirm that the Piston is properly placed over the patient’s chest. They should not start compressions until it has been properly positioned. If the Piston cannot be adjusted to reach the patient’s chest, the patient is too small and they should remove the Frame and continue manual CPR compressions.

7. Select compression protocol and start compressions.

Key Takeaways:

- Remind students that they have the choice of running compressions with or without breaths. Show how to start Run Continuous (top button) on the User Control Panel, then Run with Breaths (bottom button).
- Show how to temporarily stop compressions, if needed, by pressing the Pause Button, and to restart compressions by pressing either Pause again or the appropriate Run compressions button.

8. Apply the Stabilization Strap.

Key Takeaways:

- Show how to lift the patient's head, place the strap behind the neck, and connect to the Frame by pushing the clips into the strap connectors. They should hear an audible click.
- Show how to adjust the Stabilization Strap length to maintain the correct position of the device over the patient's chest.
- Remind students that if the device is not correctly positioned, they should loosen the Stabilization Strap and readjust.
- Show how to position and attach Wrist Straps.

9. Securing the Patient Wrist Straps to the Patient.

Key Takeaways:

- To maximize the available time to perform a rescue, it is recommended that the Patient Wrist Straps be affixed to the Frame prior to a rescue and that the Frame be stored in the Carrying Case with the Patient Wrist Straps already attached to the Frame.
- When attaching the Frame to the Backboard, the Patient Wrist Straps can be oriented towards the patient's head to maintain access to the Frame's Backboard Release Levers or on the opposite side of the Frame as appropriate.

10. Change the Battery Pack.

Key Takeaways:

- Show how to push Pause to temporarily stop compressions, then eject and replace the existing Battery Pack with a spare charged Battery Pack.
- Remind students that the Battery Pack will operate in either orientation (with the contacts toward the unit).
- Remind students that the Battery Pack must always be inserted into the Compression Module even when using an external power source.

4 Resources

COMPETENCY CHECKLIST

Student Name _____

Step	Essential Skill Set – Operation Sequence	Performed Correctly (Circle One)	
1	Opens the Carrying Case and removes the Backboard.	YES	NO
2	Places the Backboard under the patient and positions it correctly.	YES	NO
3	Removes the Frame; lifts the patient’s arms over the head; and attaches the Frame. Pulls up on the Frame to test that it is securely locked in place.	YES	NO
4	Removes the Compression Module; checks to make sure a Patient Interface Pad and a Battery Pack is installed, and inserts it into the Frame, rotating to lock into place.	YES	NO
5	Adjusts the position of the Compression Piston.	YES	NO
6	Turns the device on.	YES	NO
7	Selects compression protocol and starts compressions.	YES	NO
8	Applies the Stabilization Strap.	YES	NO
9	Applies the Wrist Straps.	YES	NO
10	Changes the Battery Pack.	YES	NO

STUDENT SELF-TEST

Step	Essential Skill Set – Deployment
1	Open the Carrying Case and remove the Backboard.
2	Place the Backboard under the patient and position as needed.
3	Attach the Frame to the Backboard (one side at a time or simultaneously). Pull up on the Frame to test that it is securely locked in place.
4	Remove the Compression Module and check that the Patient Interface Pad is installed. Mount in the Frame, rotating in either direction until it is in line with the Frame and locks into place.
5	Press the ON/OFF button for at least one second to turn on.
6	Adjust the position of the Piston until it firmly touches the patient’s chest.
7	Push Run Continuous or Run with Breaths button to start compressions.
8	When necessary, pause compressions to adjust Piston to maintain proper placement and positioning on patient’s chest.
9	Apply the Stabilization Strap behind the patient’s neck. Connect the Strap to the Frame with the Stabilization Strap Connectors. (Stabilization Strap can be adjusted using self-adhesive Velcro.)
10	With Patient Wrist Straps already affixed to the Frame, secure the Forearm Strap of the Patient Wrist Strap to the patient by placing the patient’s wrist on top of the Forearm Strap and placing the soft Velcro part of the strap across the patient’s wrist, then secure the patient’s wrist to the Frame by wrapping the hooked Velcro onto the soft Velcro section.

Notes:

- To minimize CPR interruptions and to most effectively use the Lifeline ARM device, two rescuers are recommended.
- Providing manual chest compressions takes precedence over setting up and initiating use of the Lifeline ARM device.

TRAINING EVALUATION for the Defibtech Lifeline ARM Device

Trainer Name / Course / Date _____

Please mark the columns that most closely reflect your thoughts after this training.

		Strongly Agree	Agree	Neutral	Disagree	Strongly Disagree
1	Training objectives were clearly defined and addressed in the course.					
2	Course content was well organized and clearly presented.					
3	The trainer was well prepared, knowledgeable, and helpful.					
4	Participation and interaction with the class were constructive and encouraged.					
5	The trainer allowed adequate time for questions and answers.					
6	The training materials provided were effective.					
7	The breakout sessions offered adequate opportunity for practice and reinforced the content taught in the class.					
8	The training session was long enough to cover the material presented.					
9	The training location and facilities were comfortable and provided adequate space for practice.					
10	The training prepared me to use the Lifeline ARM device in my work environment.					

Overall, the training was (circle one): Excellent / Good / Average / Poor / Very Poor

Comments

CERTIFICATE

OF COMPLETION

THIS DOCUMENT CERTIFIES THAT



HAS SUCCESSFULLY COMPLETED TRAINING FOR USE OF THE
DEFIBTECH LIFELINE ARM AUTOMATED CHEST COMPRESSION SYSTEM.



DATE OF TRAINING

SIGNATURE OF TRAINER



5 Contacts

Manufacturer

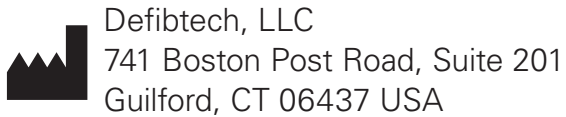

Tel.: 1-(866) 333-4241 (Toll-free within North America)
1-(203) 453-4507

Fax: 1-(203) 453-6657

Email:

sales@defibtech.com (Sales)
reporting@defibtech.com (Medical Device Reporting)
service@defibtech.com (Service and Repair)

Website:

www.defibtech.com

Authorized European Representative:



EMERGO EUROPE
Prinsessegracht 20
2514 AP The Hague
The Netherlands

